

service reference guide

HP Compaq dx2700 MT/dx2708 MT/dx2700 SFF
Business PCs
1st Edition

This document provides information on the removal and replacement of all parts as well as information on troubleshooting, Desktop Management, setup utilities, SATA drives, safety, routine care, connector pin assignments, POST error messages, and diagnostic indicator lights.

Document Part Number 431672-001



i n v e n t



Service Reference Guide

HP Compaq dx2700 MT/dx2708 MT/dx2700 SFF
Business PCs

1st Edition

Document Part Number: 431672-001

September 2006

© Copyright 2006 Hewlett-Packard Development Company, L.P.
The information contained herein is subject to change without notice.

Microsoft, MS-DOS, Windows, and Windows NT are trademarks of Microsoft Corporation in the U.S. and other countries.

Intel is a trademark of Intel Corporation in the U.S. and other countries.

The only warranties for HP products and services are set forth in the express warranty statements accompanying such products and services. Nothing herein should be construed as constituting an additional warranty. HP shall not be liable for technical or editorial errors or omissions contained herein.

This document contains proprietary information that is protected by copyright. No part of this document may be photocopied, reproduced, or translated to another language without the prior written consent of Hewlett-Packard Company.



WARNING: Text set off in this manner indicates that failure to follow directions could result in bodily harm or loss of life.



CAUTION: Text set off in this manner indicates that failure to follow directions could result in damage to equipment or loss of information.

Service Reference Guide

HP Compaq dx2700 MT/dx2708 MT/dx2700 SFF Business PCs

First Edition (September 2006)

Document Part Number: 431672-001

Contents

1 Installing the Operating System

1.1	Microsoft Windows XP/Redflag Linux	1-1
1.1.1	Installing or Upgrading Device Drivers (Only applicable for Windows OS)	1-1
1.2	Converting to NTFS (Associated with WinXP OS)	1-2
1.2.1	Windows XP Home and XP Professional	1-2
1.3	HP Software	1-2

2 Setup Utilities and Diagnostics Features

2.1	Power-On Self-Test (POST)	2-1
2.2	Computer Setup Utilities	2-2
2.2.1	Using Computer Setup (F10) Utilities	2-2
2.2.2	Computer Setup Menu	2-4
2.3	Recovering the Configuration Settings	2-11
2.3.1	Backing up the CMOS	2-11
2.3.2	Restoring the CMOS	2-11

3 Desktop Management

3.1	Initial Configuration and Deployment	3-1
3.2	ROM Flash	3-1
3.2.1	FailSafe Boot Block ROM	3-1
3.2.2	Dual-State Power Button	3-2
3.2.3	Power Management	3-2
3.2.4	World Wide Web Site	3-3
3.3	Security	3-3
3.3.1	Password Security	3-3
3.3.2	Establishing a Supervisor Password Using Computer Setup	3-3
3.3.3	Establishing a User Password Using Computer Setup	3-3
3.3.4	Surge-Tolerant Power Supply	3-6

4 Serial ATA Drive Guidelines and Features

4.1	SATA 1.5 and 3.0 Hard Drives	4-1
4.2	SATA Hard Drive Cables	4-2
4.2.1	SATA Data Cable	4-2
4.2.2	SATA Power Cable	4-2
4.3	SATA SMART Drives	4-3
4.4	Drive Capacities	4-3
4.5	SATA BIOS	4-3
4.5.1	Legacy Mode	4-4
4.5.2	Native Mode	4-4

5 Identifying the Chassis, Routine Care, and Disassembly Preparation

5.1	Chassis Designations	5-1
5.1.1	Microtower (MT)/Small Form Factor (SFF)	5-1
5.2	Electrostatic Discharge Information	5-3
5.2.1	Generating Static	5-3
5.2.2	Preventing Electrostatic Damage to Equipment	5-3
5.2.3	Personal Grounding Methods and Equipment	5-4
5.2.4	Grounding the Work Area	5-4
5.2.5	Recommended Materials and Equipment	5-4
5.3	Routine Care	5-5
5.3.1	General Cleaning Safety Precautions	5-5
5.3.2	Cleaning the Computer Case	5-5
5.3.3	Cleaning the Keyboard	5-6
5.3.4	Cleaning the Monitor	5-6
5.3.5	Cleaning the Mouse	5-6
5.4	Service Considerations	5-7
5.4.1	Tools and Software Requirements	5-7
5.4.2	Screws	5-7
5.4.3	Cables and Connectors	5-8
5.4.4	Hard Drives	5-8
5.4.5	Lithium Coin Cell Battery	5-8

6 Removal and Replacement Procedures – Microtower (MT)/Small Form Factor (SFF) Chassis

6.1	Preparation for Disassembly	6-1
6.2	Remove the computer access panel and front bezel (MT chassis and SFF chassis)	6-2
6.2.1	Access Panel (MT Chassis)	6-2
6.2.2	Front Bezel (MT Chassis)	6-3
6.2.3	Removing the Computer Access Panel and Front Bezel (SFF chassis)	6-4
6.3	Using the Small Form Factor Computer in a Minitower Configuration	6-6
6.4	Front Drive Bezels	6-7
6.4.1	Removing a 5.25" Drive Bezel Blank/MT Chassis	6-7
6.5	Memory	6-8
6.5.1	Installing Memory Modules/MT chassis	6-8
6.5.2	Installing DDR2-SDRAM DIMMs - SFF chassis	6-9
6.6	Expansion Cards	6-11
6.6.1	Expansion Slot Cover Lock	6-11
6.6.2	PCI/PCIe Expansion Card	6-11
6.6.3	Installing an Expansion Card	6-13
6.6.4	Removing an Expansion Card	6-15
6.7	Cable Management	6-16
6.8	Drives	6-17
6.8.1	Locating Drive Positions	6-17
6.8.2	Removing a Drive	6-18
6.8.3	Locating Drive Positions - SFF chassis	6-19
6.8.4	Removing an Optical Drive or Diskette Drive - SFF chassis	6-20
6.8.5	Installing an Optional Optical Drive - SFF chassis	6-21
6.8.6	Upgrading the Hard Drive - SFF chassis	6-24

6.9	Front I/O Panel Housing Assembly - MT chassis	6-26
6.10	System Fan	6-27
6.11	Heatsink - MT chassis	6-28
6.12	Processor	6-29
6.13	System Board	6-31
6.14	Battery	6-32
	6.14.1 Battery Holder	6-33
6.15	Power Supply	6-34

A Connector Pin Assignments

B Power Cord Set Requirements

C POST Error Messages

D Troubleshooting Without Diagnostics

E Memory

Installing the Operating System

Depending on the model, Microsoft Windows XP Home, Windows XP Professional or Redflag Linux is preinstalled on the computer and will be configured automatically the first time the computer is turned on.



CAUTION: Do not add optional hardware devices to your computer until the operating system is successfully installed. Doing so may cause errors and may prevent the operating system from installing properly.



CAUTION: Once the automatic installation has begun, DO NOT TURN OFF THE COMPUTER UNTIL THE PROCESS IS COMPLETE. Turning off the computer during the installation process might damage the software that runs the computer.

1.1 Microsoft Windows XP/Redflag Linux

The first time the computer is turned on, Microsoft Windows or Redflag Linux is automatically installed. This takes several minutes, depending on the system hardware configuration. Read and follow the instructions that appear on the screen to complete the installation. During this process, do not turn off your computer unless you are directed to do so.

1.1.1 Installing or Upgrading Device Drivers (Only applicable for Windows OS)

To install optional hardware devices after the OS installation is completed, you must install the device drivers for the device you are installing.

The I386 directory and its subdirectories provide the HP- or Compaq-specific integration of the operating system for the computer model and include device drivers supported by the operating system.

When prompted for the I386 directory on the operating system CD, replace the path with C:\I386 or use the *Browse* button of the dialog box to browse the computer for the I386 folder. This action points to the appropriate drivers.

The latest support software is also available from the Web site at <http://www.hp.com/support>.

At product launch, Vista capable program is applied for some of satisfied system shipment. (Major consideration of whether applicable is to meet minimum 512MB memory or not.)

Vista basic or higher level premium program will be in replace of WinXP at post launch.

1.2 Converting to NTFS (Associated with WinXP OS)

1.2.1 Windows XP Home and XP Professional

The Windows XP Home and XP Professional operating systems handle only NTFS-formatted drives. When installed, XP will, if necessary, automatically convert a FAT32 drive to NTFS.

1.3 HP Software

The Microsoft Windows XP Home or Windows XP Professional operating system is preinstalled on the computer and will be configured automatically the first time the computer is turned on. All other software is user-installed.

Certain drivers and utilities are available only in selected languages. You can obtain the latest version of these files, in English and selected other languages, in one of these ways:

- HP web site at www.hp.com
- *Restore Plus!* CD, which is supplied with many Compaq models



Additional HP software may be required in certain situations.

Setup Utilities and Diagnostics Features

Setup Utilities (F10) and diagnostic features provide information needed about the computer system when contacting Customer Support. These tools can also be used to:

- Change factory default settings and to set or change the system configuration, which may be necessary when you add or remove hardware.
- Determine if all of the devices installed on the computer are recognized by the system and functioning properly.
- Determine information about the operating environment of the computer.
- Solve system configuration errors detected but not automatically fixed during the Power-On Self-Test (POST).
- Establish and manage passwords and other security features.
- Establish and manage energy-saving timeouts.



All features identified in this chapter may not be available on all HP products.

2.1 Power-On Self-Test (POST)

POST is a series of diagnostic tests that runs automatically when the system is turned on. POST checks the following items to ensure that the computer system is functioning properly:

- Keyboard
- Memory modules
- Diskette drives
- All IDE (ATA) and SATA mass storage devices
- Processors
- Controllers



If the Supervisor Password is set, a key icon appears on the screen while POST is running. You will need to enter the password before continuing. Refer to Chapter 3, [Section 3.1, “Initial Configuration and Deployment,”](#) for information on setting, deleting, or bypassing the password.

If POST finds an error in the system, an audible and/or visual message occurs. For POST error messages and their solutions refer to [Appendix C, “POST Error Messages.”](#)

2.2 Computer Setup Utilities

Use Computer Setup Utilities (F10) to:

- Modify or restore factory default settings.
- Set the system date and time.
- Set, view, change, or verify the system configuration including settings for processor, graphics, memory, audio, storage, communications, and input devices.
- Modify the boot order of bootable devices such as hard drives, diskette drives, optical drives, USB devices.
- Configure the boot priority of IDE (ATA) and SATA hard drive controllers.
- The system is preset to always Quick Boot.
- Enable or disable Network Server Mode, which allows the computer to boot the operating system when the power-on password is enabled with or without a keyboard or mouse attached. When attached to the system, the keyboard and mouse remain locked until the power-on password is entered.
- Enable supervisor password prompting during system restarts (warm boots) as well as during power-on.
- Establish a supervisor password that controls access to Computer Setup (F10) Utility and the settings described in this section.
- Secure the integrated I/O functionality, including the serial, USB, or parallel ports, audio, or embedded NIC, so that they cannot be used until they are unsecured.
- Enable or disable removable media boot ability.
- Enable or disable removable media write ability (when supported by hardware).
- Solve system configuration errors detected but not automatically fixed during the Power-On Self-Test (POST).
- Execute self-tests on a specified IDE (ATA) hard drive (when supported by the drive).

2.2.1 Using Computer Setup (F10) Utilities

Computer Setup can be accessed only by turning on the computer or restarting the system. To access the Computer Setup Utilities menu, complete the following steps:

1. Turn on or restart the computer. If you are in Windows, click **Start > Shut Down > Restart**.
2. As soon as the computer is turned on, press and hold the **F10** key until you enter Computer Setup. Press **Enter** to bypass the title screen, if necessary.



If you do not press the **F10** key at the appropriate time, you must turn the computer off, then on again, and press the **F10** key again to access the utility.

If you are using a PS/2 keyboard, you may see a Keyboard Error message—disregard it.

3. A choice of headings appears in the Computer Setup Utilities menu: System Information, Standard CMOS Features, Advanced BIOS Features, Advanced Chipset Features, Integrated Peripherals, Power Management Setup, PnP/PCI Configurations, PC Health Status, Load Optimized Defaults, Set Supervisor Password, Set User Password, Save and Exit Setup, and Exit Without Saving.
4. Use the arrow (left and right) keys to select the appropriate heading. Use the arrow (up and down) keys to select the option you want, then press **Enter**. To return to the Computer Setup Utilities menu, press **Esc**.
5. To apply and save changes, select **Save and Exit Setup**.
 - If you have made changes that you do not want applied, select **Exit Without Saving**.
 - To reset to factory settings, select **Load Optimized Defaults**. This option will restore the original factory system defaults. You must still select **Save and Exit Setup** after resetting the defaults.



 **CAUTION:** Do NOT turn the computer power OFF while the ROM is saving your F10 Computer Setup changes because the CMOS could become corrupted. It is safe to turn off all power to the computer after you exit the F10 Setup screen.

2.2.2 Computer Setup Menu

Computer Setup		
Heading	Option	Description
System Information	System S/N	(view only)
	Product Name	(view only)
	OwnerShip TAG [Press Enter]	Enter ownership tag assigned by the owner.
	OwnerShip TAG	(view only)
	BIOS Version	(view only)
	BIOS Release Date	(view only)
	System Chipset Type	(view only)
	Processor Type	(view only)
	Processor Speed	(view only)
	CPU ID	(view only)
	Cache Size	(view only)
	Memory DIMM1	(view only)
	Memory DIMM2	(view only)
	Memory DIMM3	(view only)
	Memory DIMM4	(view only)
	DDR2 Memory Size	(view only)
	UUID	(view only)
	Chassis Serial Number	(view only)
Asset TAG Number [Press Enter]	Enter asset tag assigned by the company.	
Asset TAG Number	(view only)	
Integrated MAC	(view only)	
Standard CMOS Features	System Date	Allows you to set system date.
	System Time	Allows you to set system time.
	Floppy Drive A	Allows you to set Drive A to None or 1.44M, 3.5 inch.

 Support for specific Computer Setup options may vary depending on the hardware configuration.

Computer Setup (Continued)		
Heading	Option	Description
Standard CMOS Features (continued)	SATA Port 0 SATA Port 1 SATA Port 2 SATA Port 3	<p>For each, allows you to:</p> <ul style="list-style-type: none"> • detect HDD size and head on selected channel • set extended drive on selected channel to: <ul style="list-style-type: none"> • None • Auto • Manual • set access mode on selected channel to: <ul style="list-style-type: none"> • CHS • LBA • Large • Auto • view: <ul style="list-style-type: none"> • Capacity • Cylinder • Head • Precomp • Landing Zone • Sector <p>No SMART HDD installed.</p>
	SATA Port 0/1 Working Mode	Native Legacy
	Halt On	<p>Allows you to set at:</p> <ul style="list-style-type: none"> • All Errors • No Errors • All but Keyboard • All but Diskette • All but Disk/Key
Advanced BIOS Features	Quick Power On Self Test	<p>Disables/enables the system to skip certain tests while booting.</p> <p>Enabling this feature decreases the time required to boot the system.</p>
	POST Delay Time (seconds)	<p>Allows you to set a POST delay time to:</p> <ul style="list-style-type: none"> • 0 Sec • 5 Sec • 10 Sec • 15 Sec
<p> Support for specific Computer Setup options may vary depending on the hardware configuration.</p>		

Computer Setup (Continued)			
Heading	Option	Description	
Advanced BIOS Features <i>(continued)</i>	Hard Disk Boot Priority	Allows you to specify the order of attached hard drive devices (such as USB HDD storage, USB2 Drive Key, or USB flash media). The first drive in the order has priority in the boot sequence and is recognized as drive C (if any devices are attached).	
	First Boot Device Second Boot Device Third Boot Device Fourth Boot Device	Allows you to specify which devices will boot first, second, and third, or to disable any of the three: <ul style="list-style-type: none"> • Removable • Hard Disk • CD-ROM • Network • Disabled  MS-DOS drive lettering assignments may not apply after a non-MS-DOS operating system has started.	
	Boot Other Device	Disables/enables boot other device.	
	Load Boot Menu Selectable	Disables/enables boot menu selectable	
	APIC Mode	Disables/enables the APIC mode.	
	System Keyboard	Allows you to set system keyboard to absent or present.	
	Boot Up NumLock Status	Allows you to set the default NumLock status to off or on.	
	Security Option	Allows you to set the security option to Setup or System so that the password is required every time the system boots or only when entering Computer Setup.	
	 Support for specific Computer Setup options may vary depending on the hardware configuration.		

Computer Setup (Continued)

Heading	Option	Description
Advanced Chipset Features	PEG/Onchip VGA Control (VGA Setting)	Allows you to set system display at: <ul style="list-style-type: none"> • Onchip VGA • PEG Port • Auto
	On-Chip Frame Buffer Size (VGA Setting)	Allow you to set On-Chip Frame Buffer Size to: <ul style="list-style-type: none"> • 1MB • 8MB
	DVMT Mode (VGA Setting)	Allows you to set DVMT Mode to: <ul style="list-style-type: none"> • Fixed • DVMT
	DVMT/FIXED Memory Size (VGA Setting)	Allows you to set memory size to: <ul style="list-style-type: none"> • 128MB • 256MB • MAX.
	Init Display First (VGA Setting)	Allows you to set system display priority: <ul style="list-style-type: none"> • PCI Slot • Onboard • PCIe*



Support for specific Computer Setup options may vary depending on the hardware configuration.

Computer Setup (Continued)		
Heading	Option	Description
Integrated Peripherals	USB Controller	Disables/enables USB controller.
	USB Legacy Support	Disables/enables USB legacy support.
	HD Audio	Allows you to auto-detect or disable onboard audio.
	Onboard LAN	Disables/enables onboard LAN controller.
	Onboard LAN Boot ROM	Disables/enables the boot ROM of the onboard LAN chip.
	Onboard FDC Controller	Disables/enables onboard FDC controller.
	Serial Port	Allows you to select a setting for the onboard serial port: <ul style="list-style-type: none"> • Disabled • 3F8/IRQ4 • 2F8/IRQ3 • 3E8/IRQ4 • 2E8/IRQ3 • Auto
Parallel port	Parallel port	Allows you to select a setting for the onboard parallel port: <ul style="list-style-type: none"> • Disabled • 378/IRQ7 • 278/IRQ5 • 3BC/IRQ7
	Parallel Port Mode	Allows you to select parallel port mode: <ul style="list-style-type: none"> • Standard • EPP1.9+SPP • ECP • EPP1.9+ECP • Printer • EPP1.7+SPP
	ECP Mode Use DMA	If Parallel Port Mode is set to ECP or ECP+EPP, allows you to set the ECP Mode Use DMA to 1 or 3.

 Support for specific Computer Setup options may vary depending on the hardware configuration.

Computer Setup (Continued)		
Heading	Option	Description
Power Management Setup	ACPI Function	Enables/disables ACPI functions. Changing this item can make the existing OS unusable.
	ACPI Suspend Type	Allows you to set type of ACPI suspend to: <ul style="list-style-type: none"> • S1 (POS) • S3 (STR)
	Restore On AC/Power Loss	Allows you to select system power loss behavior: <ul style="list-style-type: none"> • On • Off • Last State
	Resume On PME	Disables/enables Resume by PME.
	Wake On Ring	Disables/enables Resume on Ring.
	Resume On Alarm	Disables/enables RTC alarm.
	Date (of Month) Alarm	If Resume by Alarm is enabled, allows you to select the day of the month for resumption of RTC alarm.
	Time (hh:mm:ss) Alarm	If Resume by Alarm is enabled, allows you to select what time the RTC alarm will resume.
PnP/PCI Configurations	Reset Configuration Data	Disables/enables automatic reconfiguration. The default is Disabled. Select Enabled to reset Extended System Configuration Data (ESCD) when you exit Setup, if you have installed a new add-on and the system reconfiguration has caused such a serious conflict that the OS cannot boot.
	Resources Controlled By	Allows you to select whether resources are controlled automatically or manually: <ul style="list-style-type: none"> • Auto (ESCD–Extended Storage Configuration Data) • Manual <p>BIOS can automatically configure all the bootable and Plug-and-Play-compatible devices. If you choose Auto, you cannot select IRQ, DMA and memory base address fields since BIOS automatically assigns them.</p>



Support for specific Computer Setup options may vary depending on the hardware configuration.

Computer Setup (Continued)		
Heading	Option	Description
PnP/PCI Configurations (continued)	IRQ Resources <ul style="list-style-type: none"> • IRQ-3 assigned to • IRQ-4 assigned to • IRQ-5 assigned to • IRQ-7 assigned to • IRQ-9 assigned to • IRQ-10 assigned to • IRQ-11 assigned to • IRQ-12 assigned to • IRQ-14 assigned to • IRQ-15 assigned to 	When resources are controlled manually, allows you to assign each system interrupt a type, depending on the type of device using the interrupt. Legacy ISA for devices compliant with the original PC AT bus specification, PCI/ISA PnP for devices compliant with the Plug-and-Play standard whether designed for PCI or ISA bus architecture.
Hardware Monitor Setup	Reset Case Open Status	Reset Case Open Status
	CPU Temperature	(view only)
	CPU Fan Speed	(view only)
	System Fan Speed	(view only)
	CPU Fan Fault Detect	Disables/enables detection of CPU failure during POST.
	SYS Fan Fault Detect	Disables/enables detection of Fan failure during POST.
Load Optimized Defaults		Allows you to reset Computer Setup to factory defaults.
Set Supervisor Password		Allows you to establish a password to control access to Computer Setup.
Set User Password		Allows you to establish a password to control access to the computer.
Save Setting and Exit		Allows you to save current settings and exit Computer Setup.
Exit Without Saving		Allows you to exit Computer Setup without saving changes.
	Support for specific Computer Setup options may vary depending on the hardware configuration.	

2.3 Recovering the Configuration Settings

Recovering the configuration settings established in the Computer Setup (F10) Utility requires that you first back up the settings before a recovery is needed.

The CMOS Save/Load utility firmware can be found at <http://www.hp.com> under the Software & Driver Downloads for your specific model. Download the firmware files into a folder on a removable storage device. It is recommended that you save any modified computer configuration settings to a diskette, a USB flash media device, or a diskette-like device (a storage device set to emulate a diskette drive) and save the diskette or device for possible future use.

2.3.1 Backing up the CMOS

1. Make sure the computer to be backed up is turned on. Connect the removable storage to the computer.
2. In Windows, click **Start > Run**, type **CMD**, and click **OK** to open a DOS command window.
3. Type **N:\folder\BIOS.exe SAVE:ABC001.DAT** (where *N* is the drive letter of the removable storage) to save the CMOS setting to the removable storage device.

2.3.2 Restoring the CMOS

1. Make sure the target computer is turned on. Connect the removable storage to the target computer.
2. In Windows, click **Start > Run**, type **CMD**, and click **OK**. to open a DOS command window.
3. Type **N:\folder\BIOS.exe LOAD:ABC001.DAT** (where *N* is the drive letter of the removable storage) to load the custom CMOS setting onto the target system.

Desktop Management



Support for specific features described in this guide may vary by model or software version.

3.1 Initial Configuration and Deployment

HP computers come with a preinstalled system software image. After a brief software “unbundling” process, the computer is ready to be used.

A customized software image may be deployed by:

- Installing additional software applications after unbundling the preinstalled software image.

The best deployment method depends on your information technology environment and processes. The PC Deployment section of the Solutions and Services Web site <http://h18000.www1.hp.com/solutions/pcsolutions> provides information to help you select the best deployment method.

The *Restore Plus!* CD, ROM-based setup, and ACPI hardware provide further assistance with recovery of system software, configuration management and troubleshooting, and power management.

3.2 ROM Flash

The computer’s BIOS is stored in a programmable flash ROM (read only memory). By establishing a supervisor password in the Computer Setup (F10) utility, you can protect the ROM from being unintentionally updated or overwritten. This is important to ensure the operating integrity of the computer. Should you need or want to upgrade the BIOS, you may download the latest BIOS images from the HP driver and support page: <http://www.hp.com/support>.



CAUTION: For maximum ROM protection, be sure to establish a supervisor password. The supervisor password prevents unauthorized ROM upgrades.

3.2.1 FailSafe Boot Block ROM

The FailSafe Boot Block ROM allows for system recovery in the unlikely event of a ROM flash failure, for example, if a power failure were to occur during a ROM upgrade. The Boot Block is a flash-protected section of the ROM that checks for a valid system ROM flash when power to the system is turned on.

- If the system ROM is valid, the system starts normally.
- If the system ROM fails the validation check, the FailSafe Boot Block ROM provides enough support to start the system from a bootable removable media that automatically invokes system BIOS upgrade utilities.

To recover the system after it enters Boot Block recovery mode, complete the following steps:

1. Remove all removable media and turn off the power.
2. Insert a diskette, CD, or USB flash device containing the desired BIOS image file in the root directory. The media must be formatted using the FAT12, FAT16, or FAT32 file system.
3. Turn on power to the system.

If no appropriate BIOS image file is found, the failsafe Boot Block BIOS will attempt to start the system from a bootable device. If no bootable device is found, you will be prompted to insert media containing a BIOS image file or BIOS upgrade utility.

If the system successfully reprograms the ROM, the system will automatically power off.

4. Remove the removable media used to upgrade the BIOS.
5. Turn the power on to restart the computer.

3.2.2 Dual-State Power Button

With Advanced Configuration and Power Interface (ACPI) enabled for Windows XP, the power button can function either as an on/off switch or as a suspend button. The suspend feature does not completely turn off power, but instead causes the computer to enter a low-power standby. This allows you to quickly power down without closing applications and to quickly return to the same operational state without any data loss.

To change the power button's configuration, complete the following steps:

1. Left click on the **Start Button**, then select **Control Panel > Power Options**.
2. In the **Power Options Properties**, select the **Advanced** tab.
3. In the **Power Button** section, select the desired power button setting.

After configuring the power button to function as a suspend button, press the power button to put the system in a very low power state (suspend). Press the button again to quickly bring the system out of suspend to full power status. To completely turn off all power to the system, press and hold the power button for four seconds.



CAUTION: Do not use the power button to turn off the computer unless the system is not responding; turning off the power without operating system interaction could cause damage to or loss of data on the hard drive.

3.2.3 Power Management

Power Management is a feature that saves energy by shutting down certain components of the computer when they are not in use, thus saving energy without having to shut down the computer.

With Advanced Configuration and Power Interface (ACPI) enabled for Windows XP, timeouts (the period of inactivity allowed before shutting down these components) can be enabled, customized, or disabled using the operating system.

1. In Windows XP, left click on the **Start Button**, then select **Control Panel > Power Options**.
2. In the **Power Options Properties**, select the **Power Schemes** tab.
3. Select the desired power scheme settings.

Use Display Properties to establish, modify, or disable Power Management settings for the monitor. To access Display Properties, right click on the **Windows Desktop**, then choose **Properties**.

3.2.4 World Wide Web Site

When making the transition to new or revised operating systems, it is important to implement the support software designed for that operating system. If you plan to run a version of Microsoft Windows that is different from the version included with your computer, you must install corresponding device drivers and utilities to ensure that all features are supported and functioning properly.

HP has made the task of locating, accessing, evaluating, and installing the latest support software easier. You can download the software from <http://www.hp.com/support>. The Web site contains the latest device drivers, utilities, and flashable ROM image needed to run the latest Microsoft Windows operating system on your HP computer.

3.3 Security

3.3.1 Password Security

The user password prevents unauthorized use of the computer by requiring entry of a password to access applications or data each time the computer is turned on or restarted. The supervisor password specifically prevents unauthorized access to Computer Setup, and can also be used as an override to the user password. That is, when prompted for the user password, entering the supervisor password instead will allow access to the computer.

A network-wide setup password can be established to enable the system administrator to log in to all network systems to perform maintenance without having to know the power-on password, even if one has been established.

3.3.2 Establishing a Supervisor Password Using Computer Setup

Establishing a supervisor password through Computer Setup prevents reconfiguration of the computer (use of the Computer Setup (F10) utility) until the password is entered.

1. Turn on or restart the computer. If you are in Windows, click **Start > Shut Down > Restart**.
2. As soon as the computer is turned on, press and hold the **F10** key until you enter Computer Setup. Press **Enter** to bypass the title screen, if necessary.



If you do not press the **F10** key at the appropriate time, you must turn the computer off, then on again, and press the **F10** key again to access the utility.

If you are using a PS/2 keyboard, you may see a Keyboard Error message—disregard it.

3. Select **Set Supervisor Password** and follow the instructions on the screen.
4. Before exiting, click **Save and Exit Setup**.

3.3.3 Establishing a User Password Using Computer Setup

Establishing a user password through Computer Setup prevents access to the computer when power is turned on, unless the password is entered. When a user password is set, Computer Setup presents Password Options under the Security menu. Password options include Password Prompt on Warm Boot. When Password Prompt on Warm Boot is enabled, the password must also be entered each time the computer is rebooted.

1. Turn on or restart the computer. If you are in Windows, click **Start > Shut Down > Restart**.
2. As soon as the computer is turned on, press and hold the **F10** key until you enter Computer Setup. Press **Enter** to bypass the title screen, if necessary.



If you do not press the **F10** key at the appropriate time, you must turn the computer off, then on again, and press the **F10** key again to access the utility.

If you are using a PS/2 keyboard, you may see a Keyboard Error message—disregard it.

3. Select **Set User Password** and follow the instructions on the screen.
4. Before exiting, click **Save and Exit Setup**.

Entering a User Password

To enter a user password, complete the following steps:

1. Turn on or restart the computer. If you are in Windows, click **Start > Shut Down > Restart**.
2. When the key icon appears on the monitor, type your current password, then press **Enter**.



Type carefully; for security reasons, the characters you type do not appear on the screen.

If you enter the password incorrectly, a broken key icon appears. Try again. After three unsuccessful tries, you must turn off the computer, then turn it on again before you can continue.

Entering a Supervisor Password

If a supervisor password has been established on the computer, you will be prompted to enter it each time you run Computer Setup.

1. Turn on or restart the computer. If you are in Windows, click **Start > Shut Down > Restart**.
2. As soon as the computer is turned on, press and hold the **F10** key until you enter Computer Setup. Press **Enter** to bypass the title screen, if necessary.



If you do not press the **F10** key at the appropriate time, you must turn the computer off, then on again, and press the **F10** key again to access the utility.

If you are using a PS/2 keyboard, you may see a Keyboard Error message—disregard it.

3. When the key icon appears on the monitor, type the setup password, then press the **Enter** key.



Type carefully; for security reasons, the characters you type do not appear on the screen.

If you enter the password incorrectly, a broken key icon appears. Try again. After three unsuccessful tries, you must turn off the computer, then turn it on again before you can continue.

Changing a User or Supervisor Password

1. Turn on or restart the computer. If you are in Windows, click **Start > Shut Down > Restart**.
To change the setup password, run **Computer Setup**.
2. To change the user password, go to step 3.

To change the supervisor password, as soon as the computer is turned on, press and hold the **F10** key until you enter Computer Setup. Press Enter to bypass the title screen, if necessary.

 If you do not press the **F10** key at the appropriate time, you must turn the computer off, then on again, and press the **F10** key again to access the utility.

If you are using a PS/2 keyboard, you may see a Keyboard Error message—disregard it.

- When the key icon appears, type your current password, a slash (/) or alternate delimiter character, your new password, another slash (/) or alternate delimiter character, and your new password again as shown:
current password/new password/new password

 Type carefully; for security reasons, the characters you type do not appear on the screen.

- Press the **Enter** key.

The new password takes effect the next time you turn on the computer.

 Refer to the “National Keyboard Delimiter Characters” section in this chapter for information about the alternate delimiter characters.
The user password and supervisor password may also be changed using the Security options in Computer Setup.

Deleting a User or Supervisor Password

- Turn on or restart the computer. If you are in Windows, click **Start > Shut Down > Restart**. To delete the supervisor password, run **Computer Setup**.
- To delete the user password, go to step 3.
To delete the supervisor password, as soon as the computer is turned on, press and hold the **F10** key until you enter Computer Setup. Press Enter to bypass the title screen, if necessary.

 If you do not press the **F10** key at the appropriate time, you must turn the computer off, then on again, and press the **F10** key again to access the utility.

If you are using a PS/2 keyboard, you may see a Keyboard Error message—disregard it.

- When the key icon appears, type your current password followed by a slash (/) or alternate delimiter character as shown:
current password/
- Press the **Enter** key.

 Refer to “National Keyboard Delimiter Characters” for information about the alternate delimiter characters. The power-on password and setup password may also be changed using the Security options in Computer Setup.

National Keyboard Delimiter Characters

Each keyboard is designed to meet country-specific requirements. The syntax and keys that you use for changing or deleting your password depend on the keyboard that came with your computer.

National Keyboard Delimiter Characters					
Arabic	/	Greek	-	Russian	/
Belgian	=	Hebrew	.	Slovakian	-
BHCSY*	-	Hungarian	-	Spanish	-
Brazilian	/	Italian	-	Swedish/Finnish	/
Chinese	/	Japanese	/	Swiss	-
Czech	-	Korean	/	Taiwanese	/
Danish	-	Latin American	-	Thai	/
French	!	Norwegian	-	Turkish	.
French Canadian	é	Polish	-	U.K. English	/
German	-	Portuguese	-	U.S. English	/

* For Bosnia-Herzegovina, Croatia, Slovenia, and Yugoslavia

Clearing Passwords

If you forget your password, you cannot access the computer. To clear the password, turn off and unplug the computer then, use the CMOS jumper j1 (clear: 1-2 normal: 2-3). Close and restart the computer.

3.3.4 Surge-Tolerant Power Supply

An integrated surge-tolerant power supply provides greater reliability when the computer is hit with an unpredictable power surge. This power supply is rated to withstand a power surge of up to 1800 volts within minimum 3 seconds without incurring any system downtime or data loss.

Serial ATA Drive Guidelines and Features



Serial ATA = SATA

HP does not support the use of a PATA (IDE) hard drive / optical drive on these models of computer.

4.1 SATA 1.5 and 3.0 Hard Drives

Serial ATA Hard Drive Characteristics	
Number of pins/conductors in data cable	7/7
Number of pins in power cable	15
Maximum data cable length	39.37 in (100 cm)
Data interface voltage differential	400-700 mV
Drive voltages	3.3 V, 5V, 12 V
Jumpers for configuring drive	N/A
Data transfer rate, 40 GB and greater	1.5 Gb/s



When attaching the SATA cable to the system board always connect the primary hard drive to SATA 0.

4.2 SATA Hard Drive Cables

4.2.1 SATA Data Cable

Always use an HP approved SATA 3.0 Gb/s cable as it is fully backwards compatible with the SATA 1.5 Gb/s drives.

SATA data cables are susceptible to damage if overflexed. Never crease a SATA data cable and never bend it tighter than a 30 mm (1.18 in) radius.

The SATA data cable is a thin, 7-pin cable designed to transmit data for only a single drive. As shown in the table, each cable has 3 grounds, and 4 transmit/receive pins.

Pin Number	Usage	Device Plug	Host Plug
P1	Ground	Ground	Ground
P2*	A+	Transmit data	Receive data
P3*	A-	Transmit data	Receive data
P4	Ground	Ground	Ground
P5**	B-	Receive data	Transmit data
P6**	B+	Receive data	Transmit data
P7	Ground	Ground	Ground

*P2 and P3 differential signal pair

**P5 and P6 differential signal pair

4.2.2 SATA Power Cable

Pin	Usage	Notes	Pin	Usage	Notes
P1	V3.3	3.3 V power	P9	V5	5 V power
P2	V3.3	3.3 V power	P10	Ground	
P3	V3.3	3.3 V power	P11	Ground	
P4	Ground		P12	Ground	
P5	Ground		P13	V 12	12 V power
P6	Ground		P14	V12	12 V power
P7	V5	5 V power	P15	V12	12 V power
P8	V5	5 V power			

4.3 SATA SMART Drives

The Self Monitoring Analysis and Recording Technology (SMART) ATA drives for the HP Personal Computers have built-in drive failure prediction that warns the user or network administrator of an impending failure or crash of the hard drive. The SMART drive tracks fault prediction and failure indication parameters such as reallocated sector count, spin retry count, and calibration retry count. If the drive determines that a failure is imminent, it generates a fault alert.

4.4 Drive Capacities

The combination of the file system and the operating system used in the computer determines the maximum usable size of a drive partition. A drive partition is the largest segment of a drive that may be properly accessed by the operating system. A single hard drive may therefore be subdivided into a number of unique drive partitions in order to make use of all of its space.

Because of the differences in the way that drive sizes are calculated, the size reported by the operating system may differ from that marked on the hard drive or listed in the computer specification. Drive size calculations by drive manufacturers are bytes to the base 10 while calculations by Microsoft are bytes to the base 2.

Drive/Partition Capacity Limits				
File System	Controller Type	Operating System	Maximum Size	
			Partition	Drive
FAT 32	ATA	Windows 2000/ XP	32 GB	128 PB
NTFS	ATA	Windows NT/2000/XP	2 TB	128 PB

4.5 SATA BIOS

Windows 2000, XP, and Linux
Enhanced Mode (default BIOS Setting) —Separate IDE controller
<ul style="list-style-type: none"> • SATA Controller 1 in Legacy/Native Mode <ul style="list-style-type: none"> - SATA 0 is accessible as Device 0 of SATA controller's Primary Channel - SATA 1 is accessible as Device 0 of SATA controller's Secondary Channel • SATA Controller 2 in Native Model <ul style="list-style-type: none"> - SATA 2 is accessible as Device 1 of SATA controller's Primary Channel - SATA 3 is accessible as Device 1 of SATA controller's Secondary Channel

4.5.1 Legacy Mode

The Legacy mode is used to access devices attached to an embedded SATA controller. Each channel of the controller requires two fixed I/O address ranges and an IRQ.

- Primary Channel
 - Command block: 1F0h - 1F7h
 - Control block: 3F6h
 - IRQ: 14
- Secondary Channel
 - Command block: 170h - 177h
 - Control block: 376h
 - IRQ: 15

4.5.2 Native Mode

The native mode is used to access devices attached to additional SATA controllers and is not supported by many legacy operating systems. Addresses are assigned by PCI Plug-n-Play BIOS and the IRQ is shared with multiple controllers. Base Address Registers for the Command and Control Block are found in the PCI Configuration Space.

- Offset 10h—Primary Command base address
- Offset 14h—Primary Control base address
- Offset 18h—Secondary Command base address
- Offset 1Ch—Secondary Control base address

Identifying the Chassis, Routine Care, and Disassembly Preparation

This chapter provides general service information for the computer. Adherence to the procedures and precautions described in this chapter is essential for proper service.



CAUTION: When the computer is plugged into an AC power source voltage is always applied to the system board. You must disconnect the power cord from the power source before opening the computer to prevent system board or component damage.

5.1 Chassis Designations

5.1.1 Microtower (MT)/Small Form Factor (SFF)



dx2700 MT



dx2708 MT



dx2700SFF

Note: dx2708 MT is only for China Market.

5.2 Electrostatic Discharge Information

A sudden discharge of static electricity from your finger or other conductor can destroy static-sensitive devices or microcircuitry. Often the spark is neither felt nor heard, but damage occurs. An electronic device exposed to electrostatic discharge (ESD) may not appear to be affected at all and can work perfectly throughout a normal cycle. The device may function normally for a while, but it has been degraded in the internal layers, reducing its life expectancy.

Networks built into many integrated circuits provide some protection, but in many cases, the discharge contains enough power to alter device parameters or melt silicon junctions.

5.2.1 Generating Static

The following table shows that:

- Different activities generate different amounts of static electricity.
- Static electricity increases as humidity decreases.

Event	Relative Humidity		
	55%	40%	10%
Walking across carpet	7,500 V	15,000 V	35,000 V
Walking across vinyl floor	3,000 V	5,000 V	12,000 V
Motions of bench worker	400 V	800 V	6,000 V
Removing bubble pack from PCB	7,000 V	20,000 V	26,500 V
Packing PCBs in foam-lined box	5,000 V	11,000 V	21,000 V



700 volts can degrade a product.

5.2.2 Preventing Electrostatic Damage to Equipment

Many electronic components are sensitive to ESD. Circuitry design and structure determine the degree of sensitivity. The following packaging and grounding precautions are necessary to prevent damage to electric components and accessories.

- To avoid hand contact, transport products in static-safe containers such as tubes, bags, or boxes.
- Protect all electrostatic parts and assemblies with conductive or approved containers or packaging.
- Keep electrostatic sensitive parts in their containers until they arrive at static-free stations.
- Place items on a grounded surface before removing them from their container.
- Always be properly grounded when touching a sensitive component or assembly.
- Avoid contact with pins, leads, or circuitry.
- Place reusable electrostatic-sensitive parts from assemblies in protective packaging or conductive foam.

5.2.3 Personal Grounding Methods and Equipment

Use the following equipment to prevent static electricity damage to equipment:

- **Wrist straps** are flexible straps with a maximum of one-megohm \pm 10% resistance in the ground cords. To provide proper ground, a strap must be worn snug against bare skin. The ground cord must be connected and fit snugly into the banana plug connector on the grounding mat or workstation.
- **Heel straps/Toe straps/Boot straps** can be used at standing workstations and are compatible with most types of shoes or boots. On conductive floors or dissipative floor mats, use them on both feet with a maximum of one-megohm \pm 10% resistance between the operator and ground.

Static Shielding Protection Levels	
Method	Voltage
Antistatic plastic	1,500
Carbon-loaded plastic	7,500
Metallized laminate	15,000

5.2.4 Grounding the Work Area

To prevent static damage at the work area, use the following precautions:

- Cover the work surface with approved static-dissipative material. Provide a wrist strap connected to the work surface and properly grounded tools and equipment.
- Use static-dissipative mats, foot straps, or air ionizers to give added protection.
- Handle electrostatic sensitive components, parts, and assemblies by the case or PCB laminate. Handle them only at static-free work areas.
- Turn off power and input signals before inserting and removing connectors or test equipment.
- Use fixtures made of static-safe materials when fixtures must directly contact dissipative surfaces.
- Keep work area free of nonconductive materials such as ordinary plastic assembly aids and Styrofoam.
- Use field service tools, such as cutters, screwdrivers, and vacuums, that are conductive.

5.2.5 Recommended Materials and Equipment

Materials and equipment that are recommended for use in preventing static electricity include:

- Antistatic tape
- Antistatic smocks, aprons, or sleeve protectors
- Conductive bins and other assembly or soldering aids
- Conductive foam
- Conductive tabletop workstations with ground cord of one-megohm \pm 10% resistance
- Static-dissipative table or floor mats with hard tie to ground
- Field service kits

- Static awareness labels
- Wrist straps and footwear straps providing one-megohm +/- 10% resistance
- Material handling packages
- Conductive plastic bags
- Conductive plastic tubes
- Conductive tote boxes
- Opaque shielding bags
- Transparent metallized shielding bags
- Transparent shielding tubes

5.3 Routine Care

5.3.1 General Cleaning Safety Precautions

1. Never use solvents or flammable solutions to clean the computer.
2. Never immerse any parts in water or cleaning solutions; apply any liquids to a clean cloth and then use the cloth on the component.
3. Always unplug the computer when cleaning with liquids or damp cloths.
4. Always unplug the computer before cleaning the keyboard, mouse, or air vents.
5. Disconnect the keyboard before cleaning it.
6. Wear safety glasses equipped with side shields when cleaning the keyboard.

5.3.2 Cleaning the Computer Case

Follow all safety precautions in [Section 5.3.1, “General Cleaning Safety Precautions,”](#) before cleaning the computer.

To clean the computer case, follow the procedures described below:

- To remove light stains or dirt, use plain water with a clean, lint-free cloth or swab.
- For stronger stains, use a mild dishwashing liquid diluted with water. Rinse well by wiping it with a cloth or swab dampened with clear water.
- For stubborn stains, use isopropyl (rubbing) alcohol. No rinsing is needed as the alcohol will evaporate quickly and not leave a residue.
- After cleaning, always wipe the unit with a clean, lint-free cloth.
- Occasionally clean the air vents on the computer. Lint and other foreign matter can block the vents and limit the airflow.

5.3.3 Cleaning the Keyboard

Follow all safety precautions in [Section 5.3.1, “General Cleaning Safety Precautions,”](#) before cleaning the keyboard.

To clean the tops of the keys or the keyboard body, follow the procedures described in [Section 5.3.2, “Cleaning the Computer Case.”](#)

When cleaning debris from under the keys, review all rules in [Section 5.3.1, “General Cleaning Safety Precautions,”](#) before following these procedures:



CAUTION: Use safety glasses equipped with side shields before attempting to clean debris from under the keys.

- Visible debris underneath or between the keys may be removed by vacuuming or shaking.
- Canned, pressurized air may be used to clean debris from under the keys. Caution should be used as too much air pressure can dislodge lubricants applied under the wide keys.
- If you remove a key, use a specially designed key puller to prevent damage to the keys. This tool is available through many electronic supply outlets.



CAUTION: Never remove a wide leveled key (like the space bar) from the keyboard. If these keys are improperly removed or installed, the keyboard may not function properly.

- Cleaning under a key may be done with a swab moistened with isopropyl alcohol and squeezed out. Be careful not to wipe away lubricants necessary for proper key functions. Use tweezers to remove any fibers or dirt in confined areas. Allow the parts to air dry before reassembly.

5.3.4 Cleaning the Monitor

- Wipe the monitor screen with a clean cloth moistened with water or with a towelette designed for cleaning monitors. Do not use sprays or aerosols directly on the screen; the liquid may seep into the housing and damage a component. Never use solvents or flammable liquids on the monitor.
- To clean the monitor body follow the procedures in [Section 5.3.2, “Cleaning the Computer Case.”](#)

5.3.5 Cleaning the Mouse

Before cleaning the mouse, ensure that the power to the computer is turned off.

- Clean the mouse ball by first removing the retaining plate and the ball from the housing. Pull out any debris from the ball socket and wipe the ball with a clean, dry cloth before reassembly.
- To clean the mouse body, follow the procedures in [Section 5.3.2, “Cleaning the Computer Case.”](#)

5.4 Service Considerations

Listed below are some of the considerations that you should keep in mind during the disassembly and assembly of the computer.

5.4.1 Tools and Software Requirements

To service the computer, you need the following:

- Torx T-15 screwdriver (Compaq screwdriver with bits, PN 161946-001)
- Torx T-15 screwdriver with small diameter shank (for certain front bezel removal)
- Flat-bladed screwdriver (may sometimes be used in place of the Torx screwdriver)
- Diagnostics software
- Compaq tamper-resistant T-15 wrench (Smart Cover FailSafe Key, PN 166527-001) or Compaq tamper-resistant bits (Smart Cover FailSafe Key, PN 166527-002)

5.4.2 Screws

The screws used in the computer are not interchangeable. They may have standard or metric threads and may be of different lengths. If an incorrect screw is used during the reassembly process, it can damage the unit. HP strongly recommends that all screws removed during disassembly be kept with the part that was removed, then returned to their proper locations.



Metric screws have a black finish.

U.S. (Unified Standard) screws have a silver finish and are only used on hard drives.



As each subassembly is removed from the computer, it should be placed away from the work area to prevent damage.

5.4.3 Cables and Connectors

Most cables used throughout the unit are flat, flexible cables. These cables must be handled with care to avoid damage. Apply only the tension required to seat or unseat the cables during insertion or removal from the connector. Handle cables by the connector whenever possible. In all cases, avoid bending or twisting the cables, and ensure that the cables are routed in such a way that they cannot be caught or snagged by parts being removed or replaced.



CAUTION: When servicing this computer, ensure that cables are placed in their proper location during the reassembly process. Improper cable placement can damage the computer.

5.4.4 Hard Drives

Handle hard drives as delicate, precision components, avoiding all physical shock and vibration. This applies to failed drives as well as replacement spares.

- If a drive must be mailed, place the drive in a bubble-pack mailer or other suitable protective packaging and label the package “Fragile: Handle With Care.”
- Do not remove hard drives from the shipping package for storage. Keep hard drives in their protective packaging until they are actually mounted in the system unit.
- Avoid dropping drives from any height onto any surface.
- If you are inserting or removing a hard drive, turn off the computer. Do not remove a hard drive while the computer is on or in standby mode.
- Before handling a drive, ensure that you are discharged of static electricity. While handling a drive, avoid touching the connector. For more information about preventing electrostatic damage, refer to [Section 5.2, “Electrostatic Discharge Information.”](#)
- Do not use excessive force when inserting a drive.
- Avoid exposing a hard drive to liquids, temperature extremes, or products that have magnetic fields such as monitors or speakers.

5.4.5 Lithium Coin Cell Battery

The battery that comes with the computer provides power to the real-time clock and has a minimum lifetime of about three years.

See the appropriate removal and replacement chapter for the chassis you are working on in this guide for instructions on the replacement procedures.



WARNING: This computer contains a lithium battery. There is a risk of fire and chemical burn if the battery is handled improperly. Do not disassemble, crush, puncture, short external contacts, dispose in water or fire, or expose it to temperatures higher than 140°F (60°C).

CAUTION: Batteries, battery packs, and accumulators should not be disposed of together with the general household waste.

Removal and Replacement Procedures— Microtower (MT)/Small Form Factor (SFF) Chassis

Adherence to the procedures and precautions described in this chapter is essential for proper service. After completing all necessary removal and replacement procedures, run the Diagnostics utility to verify that all components operate properly.



Not all features listed in this guide are available on all computers.

6.1 Preparation for Disassembly

See [Chapter 5, “Identifying the Chassis, Routine Care, and Disassembly Preparation,”](#) for initial procedures.

1. Close any open software applications.
2. Exit the operating system.
3. Remove any diskette or compact disc from the computer.
4. Turn off the computer and any peripheral devices that are connected to it.



CAUTION: Turn off the computer before disconnecting any cables.



CAUTION: Regardless of the power-on state, voltage is always present on the system board as long as the system is plugged into an active AC outlet. In some systems the cooling fan is on even when the computer is in the “Standby,” or “Suspend” modes. The power cord should always be disconnected before servicing a unit.

5. Disconnect the power cord from the electrical outlet and then from the computer.
6. Disconnect all peripheral device cables from the computer.



During disassembly, label each cable as you remove it, noting its position and routing. Keep all screws with the units removed.



CAUTION: The screws used in the computer are of different thread sizes and lengths; using the wrong screw in an application may damage the unit.

6.2 Remove the computer access panel and front bezel (MT chassis and SFF chassis)

6.2.1 Access Panel (MT Chassis)

1. Prepare the computer for disassembly (Section 6.1, “Preparation for Disassembly”).

 **CAUTION:** Before removing the computer access panel, ensure that the computer is turned off and that the power cord is disconnected from the electrical outlet.

2. Disconnect the power cord from the computer and from the power source ❶.
3. Remove the screw that secures the access panel to the computer chassis ❷.
4. Slide the access panel back about 10 mm (3/8 inch), then lift it away from and off the unit ❸.

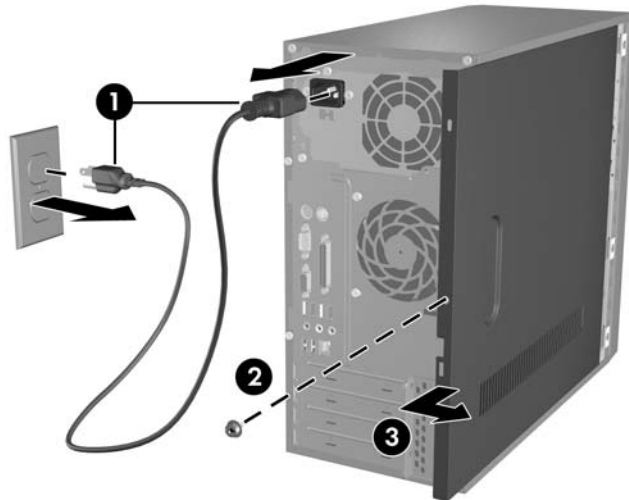

To replace the access panel, reverse the removal steps.

6.2.2 Front Bezel (MT Chassis)

1. Prepare the computer for disassembly (Section 6.1, “Preparation for Disassembly”).
2. Remove the access panel (Section 6.2.1, “Access Panel (MT Chassis)”).
3. Press down on all four tabs on the bottom of bezel then rotate the bezel off the chassis.



* These apply for selected models and countries only.

4. Continue to rotate the bezel, then push the bezel to the bottom to release the top latches from chassis.

To reinstall the front bezel, reverse the removal procedure.

5. Position the chassis in the upright position. Insert the four tabs at the bottom of the bezel. Snap into the slots of the chassis. Align the two hooks on the top of the bezel into the rectangular holes on the chassis, then rotate the bezel into the place.

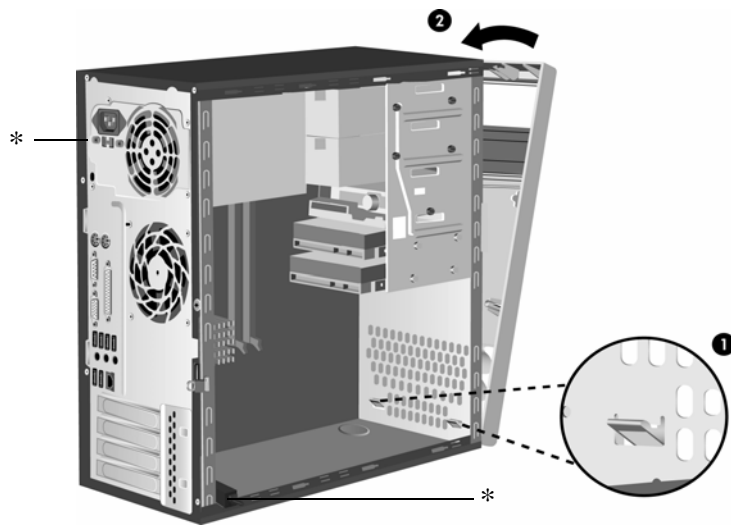

* These apply for selected models and countries only.

6.2.3 Removing the Computer Access Panel and Front Bezel (SFF chassis)

To remove the computer access panel:

1. Turn off the computer properly through the operating system, then turn off any external devices.
2. Disconnect the power cord from the power outlet and the computer, and disconnect any external devices.



CAUTION: Before removing the computer access panel, ensure that the computer is turned off and that the power cord is disconnected from the electrical outlet.



Lay the computer on its side (with the computer access panel facing up) *before* removing the computer access panel and installing hardware.

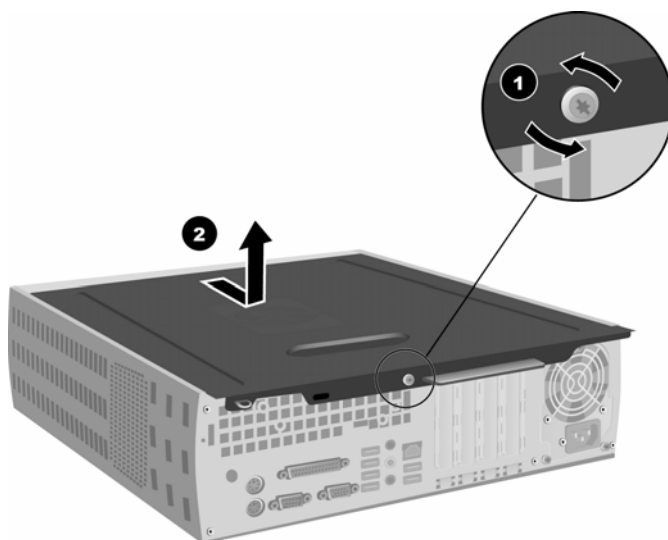

3. Loosen the screw on the rear of the computer **1**, slide the access panel toward the rear of the computer **2**, then lift it off.

Removing the Computer Access Panel

4. To remove the front bezel, gently pull up all three tabs ❶ on the top of the bezel, then pull the bezel ❷ away from the chassis.

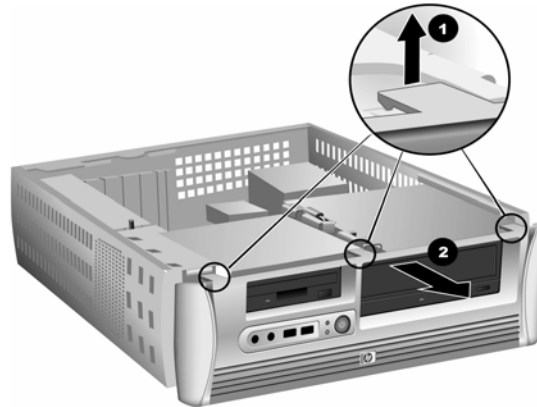

Removing the Front Bezel

To reassemble the computer, reverse the above procedure.



Press down while replacing the access panel. Refer to the label on the inside of the access panel for more information.



To re-install the front bezel, insert the two bezel bottom tabs, then rotate the front bezel forward to snap the three tabs on the top of the bezel in place.

6.3 Using the Small Form Factor Computer in a Minitower Configuration

The Small Form Factor computer can be used in either a minitower or desktop configuration. To use it in the minitower configuration, you must purchase a tower stand from HP (part number 316593-001).



CAUTION: If the computer is in the desktop configuration, ensure at least 4 inches (10.2 cm) of space on all sides of the computer remains clear and free of obstructions.

To install the tower stand:

1. Rotate the computer into the tower position ❶ and align the hole at the base of the computer with the post and thumbscrew in the stand ❷.
2. Tighten the screw to secure the computer to the stand ❸. This adds stability and helps to ensure proper airflow to the internal components.

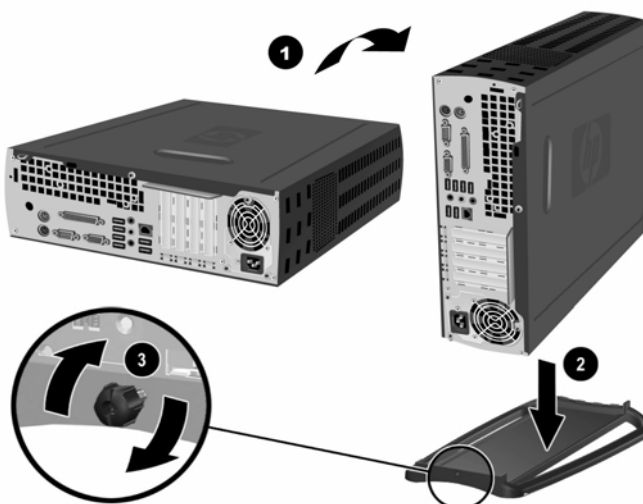

Installing the Tower Stand

6.4 Front Drive Bezels

1. Prepare the computer for disassembly (Section 6.1, “Preparation for Disassembly”).
2. Remove the access panel and the front bezel - MT (Section 6.2.1, “Access Panel (MT Chassis)” and Section 6.2.2, “Front Bezel (MT Chassis)”).
3. Remove the access panel and the front bezel -SFF (Section 6.2.3, “Removing the Computer Access Panel and Front Bezel (SFF chassis)”).

6.4.1 Removing a 5.25" Drive Bezel Blank/MT Chassis

If the computer was not shipped with a drive in the 5.25" option bay, the bay will be covered by a bezel blank. If you add a drive to the option bay, you must first remove the bezel blank.

1. Turn off the computer properly through the operating system and turn off any external devices.
2. Disconnect the power cord from the power outlet and the computer, and disconnect any external devices.
3. Remove the access panel and front bezel. Refer to Section 6.2, “Remove the computer access panel and front bezel (MT chassis and SFF chassis)”.
4. While facing the inside of the front bezel, press the two retaining tabs on the right towards the outer edge of the bezel ❶ and pull the bezel blank inwards to remove it ❷.

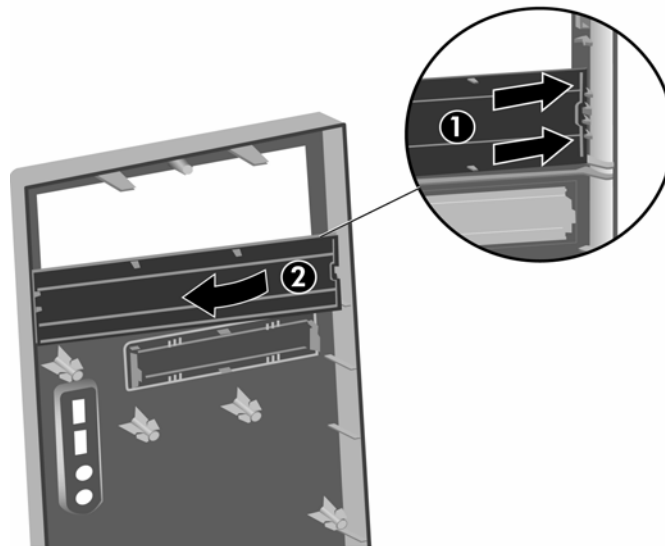

Removing a Bezel Blank





To install a bezel blank, slide the left side of the blank into the two retainer slots on the left side of the front bezel then snap the right side of the blank into place.

6.5 Memory

For more information on the memory in this series of computers, refer to [Appendix E, “Memory.”](#)

6.5.1 Installing Memory Modules/MT chassis

 **CAUTION:** The memory module sockets have gold metal contacts. When upgrading the memory, it is important to use memory modules with gold metal contacts to prevent corrosion and/or oxidation resulting from having incompatible metals in contact with each other.

 **CAUTION:** Static electricity can damage the electronic components of the computer or optional cards. Before beginning these procedures, ensure that you are discharged of static electricity by briefly touching a grounded metal object. Refer to Chapter 5 for more information.

 **CAUTION:** When handling a memory module, be careful not to touch any of the contacts. Doing so may damage the module.

1. Prepare the computer for disassembly ([Section 6.1, “Preparation for Disassembly”](#)).
 2. Remove the access panel ([Section 6.2, “Remove the computer access panel and front bezel \(MT chassis and SFF chassis\)”](#)).
-

 **WARNING:** To reduce risk of personal injury from hot surfaces, allow the internal system components to cool before touching.

3. Lay the computer down on its side to make it easier to work on.
4. Open both latches of the memory module socket **1**, and insert the memory module into the socket **2**. Begin by installing a module into the socket second nearest the preinstalled module, and install the modules following the numerical order of the sockets.

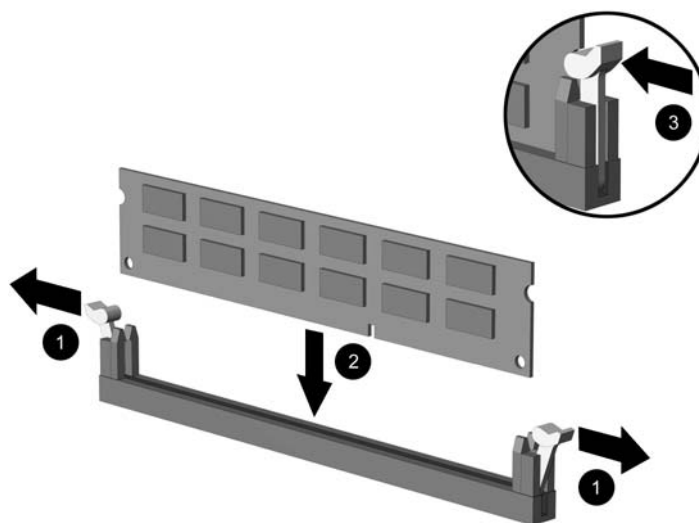



 A memory module can be installed in only one way. Match the notch on the module with the tab on the memory socket.

5. Push the module down into the socket, ensuring that the module is fully inserted and properly seated. Make sure the latches are in the closed position ③.
6. Repeat steps 4 and 5 for any additional modules that you want to install.

To reassemble the computer, reverse the removal procedure.

6.5.2 Installing DDR2-SDRAM DIMMs - SFF chassis

 **CAUTION:** The memory module sockets have gold metal contacts. When upgrading the memory, it is important to use memory modules with gold metal contacts to prevent corrosion and/or oxidation resulting from having incompatible metals in contact with each other.

 **CAUTION:** Static electricity can damage the electronic components of the computer or optional cards. Before beginning these procedures, ensure that you are discharged of static electricity by briefly touching a grounded metal object.

 **CAUTION:** When handling a memory module, be careful not to touch any of the contacts. Doing so may damage the module.

1. Turn off the computer properly through the operating system, then turn off any external devices.
2. Disconnect the power cord from the power outlet and disconnect any external devices.
3. Remove the computer access panel and front bezel.

 **CAUTION:** Check the position of all cables and wires before raising or lowering the Easy Access drive bay to prevent damage.

4. Rotate the Easy Access drive bay to an upright position.

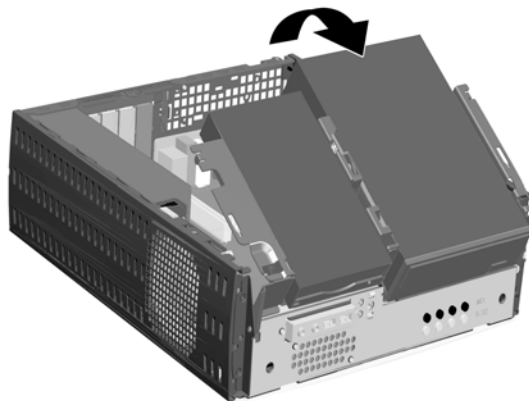

Rotating the Easy Access Drive Bay

5. Locate the memory module sockets.



WARNING: To reduce risk of personal injury from hot surfaces, allow the internal system components to cool before touching.

6. Open both latches of the memory module socket ❶, then insert the memory module into the socket ❷.

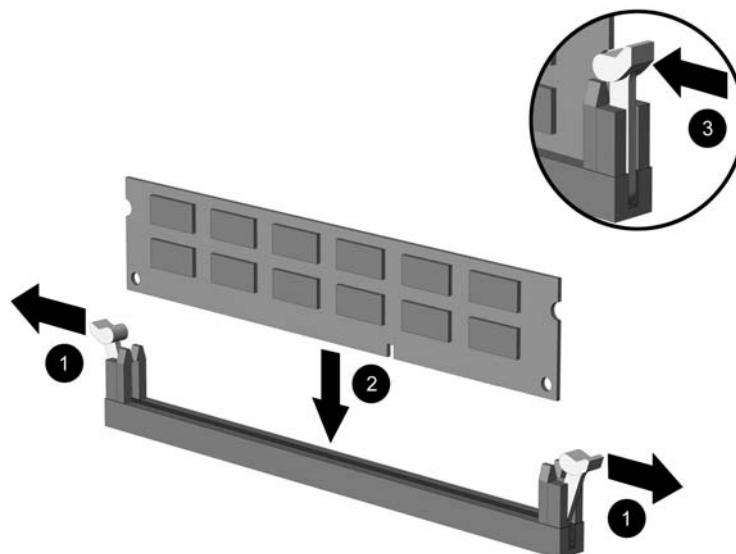

Installing a DIMM



A memory module can be installed in only one way. Match the notch on the module with the tab on the memory socket.



If you have one preinstalled DIMM in socket XMM1 and are adding a second DIMM, it is recommended that you install an identical DIMM into the XMM2 socket. If you are populating all four DIMM sockets, use identical DIMMs in each socket. Otherwise, the computer will not operate in dual channel mode. For maximum performance, populate the sockets so that the memory capacity of Channel A is equal to the memory capacity of Channel B. For example, if you have one preinstalled DIMM in socket XMM1 and are adding a second DIMM, it is recommended that you will install a DIMM of equal memory capacity into the XMM3 or XMM4 socket.

7. Push the module down into the socket, ensuring that the module is fully inserted and properly seated. Make sure the latches are in the closed position ❸.

6.6 Expansion Cards

6.6.1 Expansion Slot Cover Lock

1. Prepare the computer for disassembly (Section 6.1, “Preparation for Disassembly”).
2. Remove the right access panel (Section 6.2, “Remove the computer access panel and front bezel (MT chassis and SFF chassis)”).
3. Lay the computer down on its side to make it easier to work on.
4. On the rear of the computer, remove the retaining screw ❶ then, slide the slot cover lock up ❷ to access the expansion slot cover.

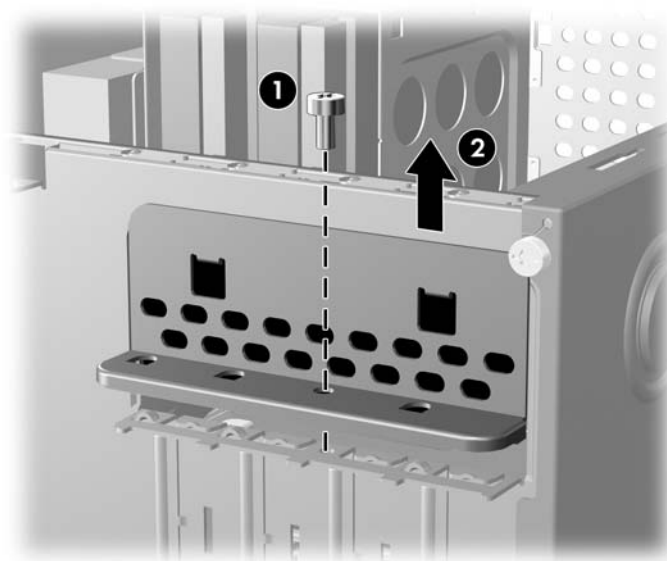

To reinstall the slot cover lock, reverse the removal procedure.

6.6.2 PCI/PCIe Expansion Card

To remove an expansion card continue with step 1.

To install an expansion card in an existing empty slot go to step 9.

1. Prepare the computer for disassembly (Section 6.1, “Preparation for Disassembly”).
2. Remove the right access panel (Section 6.2, “Remove the computer access panel and front bezel (MT chassis and SFF chassis)”).
3. Lay the computer down on its side to make it easier to work on.
4. Remove the slot cover lock (Section 6.6.1, “Expansion Slot Cover Lock”).
5. Disconnect any cables attached to the expansion card.
6. Hold the card at each end and carefully rock it back and forth until the connectors pull free from the socket. Be sure not to scrape the card against other components.
7. Store the card in anti-static packaging.
8. Install a new expansion card or an expansion slot cover to close the open slot.

If not installing a replacement expansion card, skip to step 10.

To install an expansion card in an empty slot continue with step 9.

9. With the card aligned so the mounting bracket will fit firmly against the computer backwall ❶, slide the expansion card into the expansion socket and press it firmly into place ❷.

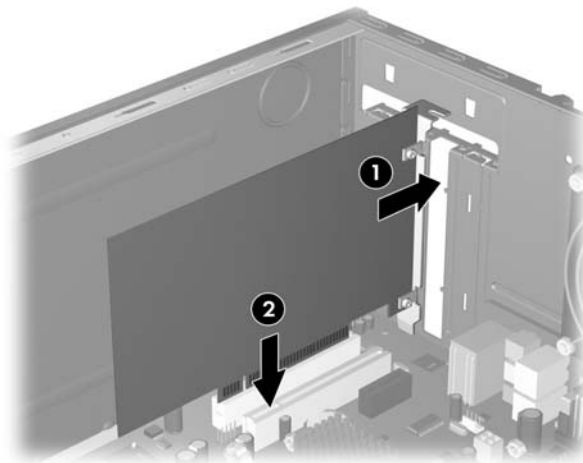

When you install an expansion card, make sure you press firmly on the card so that the entire connector seats properly in the expansion card socket.

10. Reinstall the slot cover lock and its retaining screw.
11. Replace the access panel.
12. Connect external cables to the installed card, if needed.

Reconfigure the computer, if necessary.

6.6.3 Installing an Expansion Card

The computer has four PCI expansion slots. Each slot can accommodate a half-height PCI or PCI Express expansion card up to 6.6 inches (16.764 cm) in length.



You can install a PCI card or a PCI Express x1, x4, x8 expansion card in each expansion slot.

To install an expansion card:

1. Turn off the computer properly through the operating system, then turn off any external devices.
2. Disconnect the power cord from the power outlet and disconnect any external devices.
3. Remove the computer access panel.
4. Identify the slot into which you want to insert the expansion card.
5. Release the slot cover by removing the screw that secures the PCI slot covers by pulling the latch up ❶.
6. Remove the slot cover by sliding the slot cover up and pulling it toward the inside of the chassis ❷.

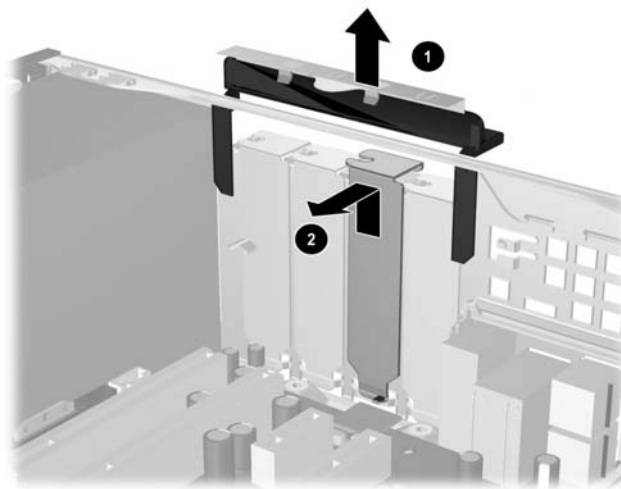

Removing the Expansion Slot Cover

7. Install the expansion card by carefully placing the expansion card under the slot cover retention latch ❶, then firmly pushing the expansion card into the connector ❷. Ensure that the expansion card is firmly and properly seated in the expansion card slot.



Be sure not to scrape other components in the chassis when installing an expansion card.

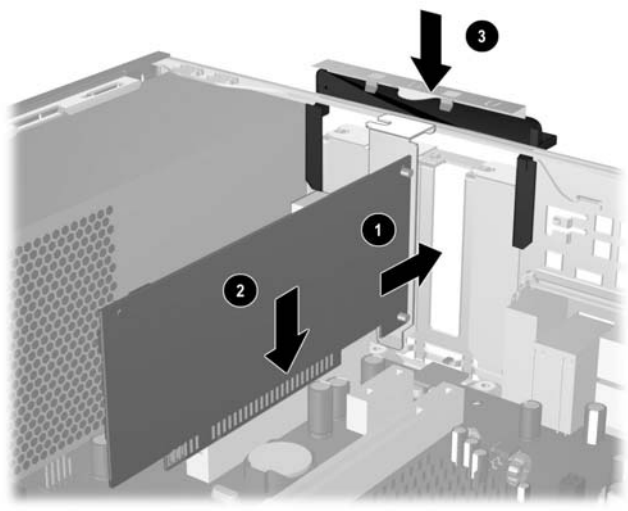

Installing an Expansion Card

8. Fix the screw to secure the expansion card in place.
9. If you are *not* replacing the old expansion card with a new expansion card, install an expansion slot cover to close the open slot. Insert the metal slot cover in the open slot, then push the expansion slot latch down to secure the slot cover in place.



CAUTION: After removing an expansion card, you must replace it with a new card or cover the open slot (for example, with a metal slot cover or a piece of duct tape) for proper cooling of internal components during operation.)

6.6.4 Removing an Expansion Card

To remove an expansion card:

1. Turn off the computer properly through the operating system, then turn off any external devices.
2. Disconnect the power cord from the power outlet and disconnect any external devices.
3. Remove the computer cover.
4. Release the slot cover retention latch on the back of the computer that secures the PCI slot covers by pulling the latch up.
5. Carefully rock the card back and forth until the connectors pull free from the socket. Pull the expansion card straight up from the socket then away from the inside of the chassis. Be sure not to scrape the card against the other components.
6. Store the card in anti-static packaging.
7. If you are not installing a new expansion card, install an expansion slot cover to close the open slot.
8. Push the expansion slot cover latch down to secure the expansion cards and expansion slot covers.



CAUTION: All expansion card slots on the rear of the computer must contain either an expansion card or slot cover for proper cooling of internal components during operation.

6.7 Cable Management

Always follow good cable management practices when working inside the computer.

- Keep cables away from major heat sources like the heatsink.
- Do not jam cables on top of expansion cards or memory modules. Printed circuit cards like these are not designed to take excessive pressure on them.
- When folding a flat ribbon cable, never fold to a sharp crease. Sharp creases may damage the wires.
- Some flat ribbon cables come prefolded. Never change the folds on these cables.
- Do not bend any cable sharply. A sharp bend can break the internal wires.
- Never bend a SATA data cable tighter than a 30 mm (1.18 in) radius.
- Never crease a SATA data cable.
- Do not rely on components like the drive cage, power supply, or computer cover to push cables down into the chassis. Always position the cables to lay properly by themselves.

When removing the power supply power cables from the P1 or P3 connectors on the system board, always follow these steps:

1. Squeeze on the top of the retaining latch attached to the cable end of the connector ❶.
2. Grasp the cable end of the connector and pull it straight up ❷.

 **CAUTION:** Always pull the connector - NEVER pull on the cable. Pulling on the cable could damage the cable and result in a failed power supply.

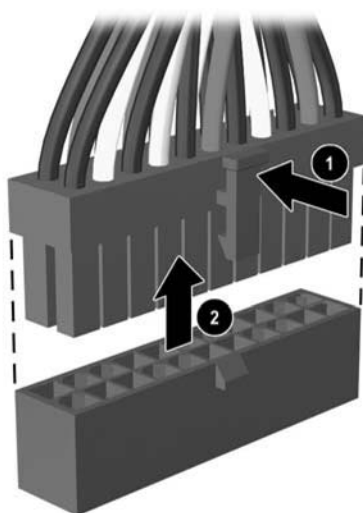

6.8 Drives

The computer supports up to four drives that may be installed in various configurations.

This Section describes the procedure for replacing or upgrading the storage drives. A Torx T-15 screwdriver is needed to remove and install the guide screws on a drive.

CAUTION: Make sure personal files on the hard drive are backed up to an external storage device before removing the hard drive. Failure to do so will result in data loss. After replacing the primary hard drive, you will need to run the *Restore Plus!* CD to load the Compaq factory-installed files.

6.8.1 Locating Drive Positions

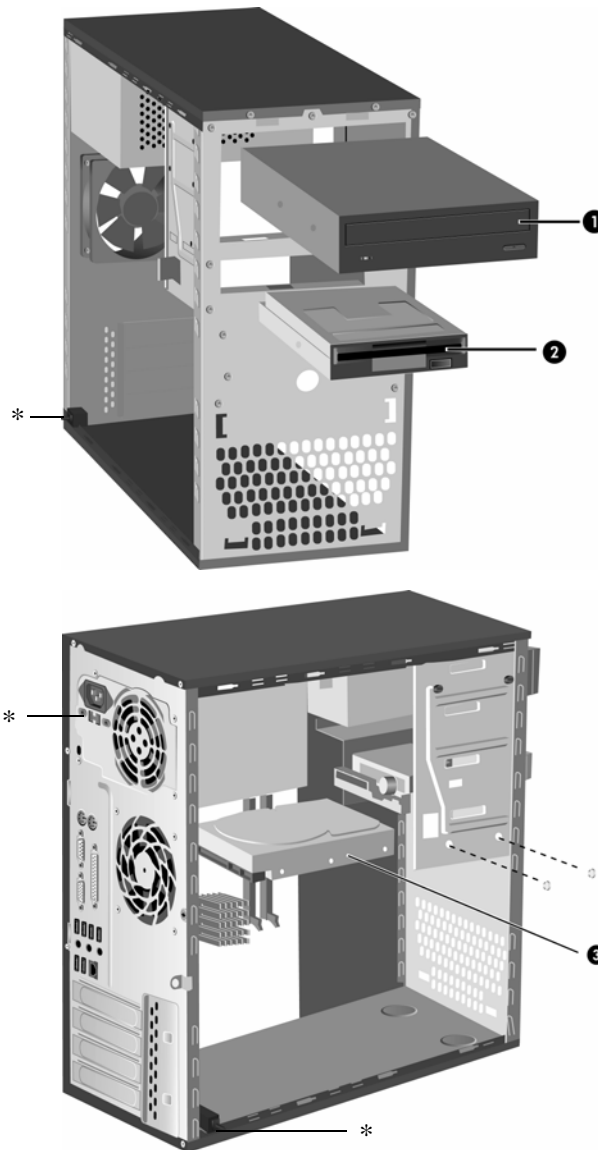

* These apply for selected models and countries only.

Drive Positions

Drive Positions	
Item	Description
❶	First 5.25-inch, half-height bays for optional drives Second 5.25-inch, half-height bays for optional drives
❷	One standard 3.5-inch, one-third height bays (1.44-MB diskette drive shown)
❸	One internal 3.5-inch, one-third height bays for hard drives An internal 3.5-inch bracket kit for second hard drives is available as option.

6.8.2 Removing a Drive

1. Turn off the computer properly through the operating system and turn off any external devices. Disconnect the power cord from the power outlet and disconnect any external devices.
2. Remove the access panel and front bezel.
3. Disconnect the power and data cables from the back of the drive, as indicated in the following illustrations.
4. Remove all the screws that secures the drives in the drive bay. Slide the drive disk forward and out of the bay.

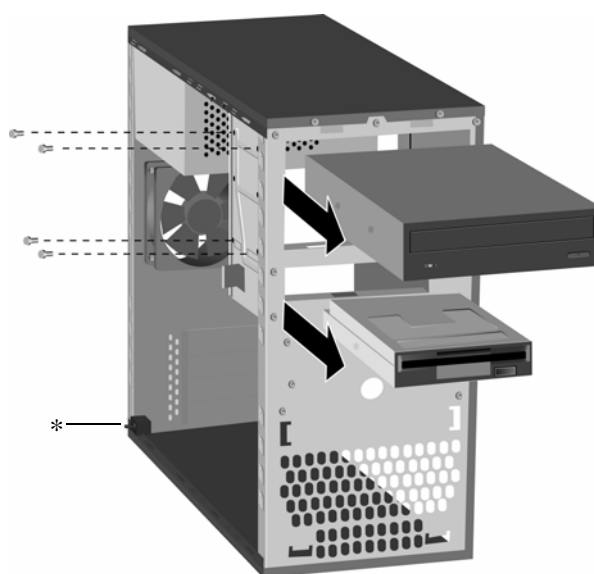

* These apply for selected models and countries only.

Removing the Drives

5. Hard disk is inserted or slide out from the back.

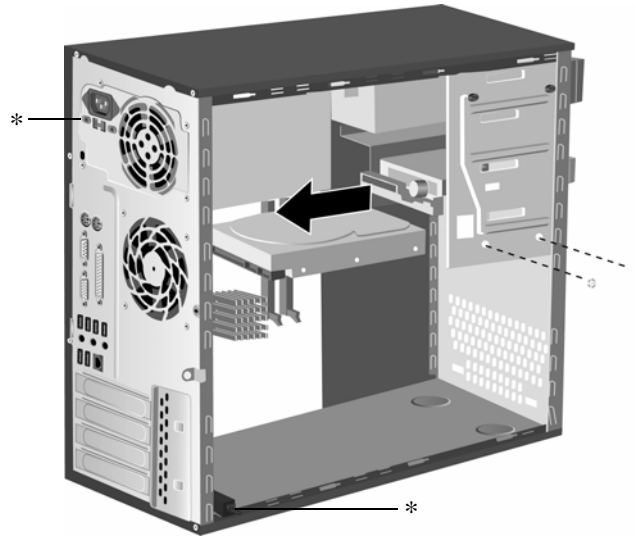

* These apply for selected models and countries only.

Removing the Hard disk

6. Remove one guide screws (Floppy Drive only) from the old drive. You will need these screws to install a new drive.



WARNING: There may be sharp edges on the insides of the bay opening after the shield has been removed.

6.8.3 Locating Drive Positions - SFF chassis

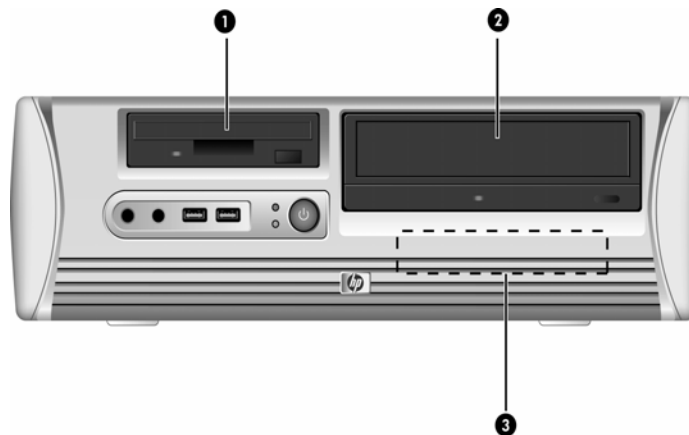

Desktop Drive Positions

-
- ❶ 3.5-inch drive bay (1.44-MB diskette drive shown)*

 - ❷ 5.25-inch drive bay for optional drives

 - ❸ 3.5-inch, internal, standard hard drive bay

*If the computer has a 1.44-MB diskette drive installed, it will be configured with a diskette drive bezel as shown in the illustration. If the computer contains an empty 3.5-inch drive bay, then a bezel blank will be installed on the computer instead. If you do not have a drive in this slot, you may choose to install a 3.5-inch device (such as a diskette drive, hard drive, or Zip drive) later on. However, to install a 3.5-inch device other than a diskette drive or hard drive, you must order the 3.5-inch device bezel (PN 434484-001).

To verify the type, size, and capacity of the storage devices installed in the computer, run Computer Setup. Refer to the *Computer Setup (F10) Utility Guide* for more information.

6.8.4 Removing an Optical Drive or Diskette Drive - SFF chassis



CAUTION: All removable media should be taken out of the drives before removing the drive from the computer.



An optical drive is a CD-ROM, CD-RW, or DVD-ROM drive.

1. Turn off the computer properly through the operating system, then turn off any external devices.
 2. Disconnect the power cord from the power outlet and disconnect any external devices.
 3. Remove the computer access panel and front bezel.
 4. Raise the Easy Access drive bay to the upright position.
 5. Disconnect the audio, signal, and drive power cables. The other end of the audio cable should remain connected to the audio connector on the system board.
-



Only Linux systems will have an audio cable connected to the optical drive.

6. Return the Easy Access drive bay to the up position.

7. Remove the screws ❶ that secure Floppy drive and Optical drive.

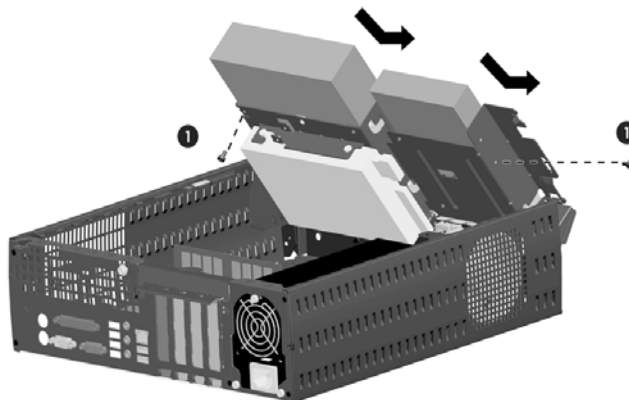

Removing the Optical Drive or Diskette Drive

To replace the drive, reverse the removal procedures.



When replacing the drive, transfer the four screws from the old drive to the new one. The screws take the place of drive rails.

6.8.5 Installing an Optional Optical Drive - SFF chassis

To install an optional optical drive:

1. Remove the optical drive if present.
2. Install the guide screws as indicated.



CAUTION: Use only 3/16-inch or 5-mm long screws as guide screws. Longer screws can damage the internal components of the drive.



Installing Guide Screws in the Optical Drive

3. Position the guide screws on the drive into the J-slots in the drive bay **1**. Then, slide the drive toward the rear of the computer **2**.

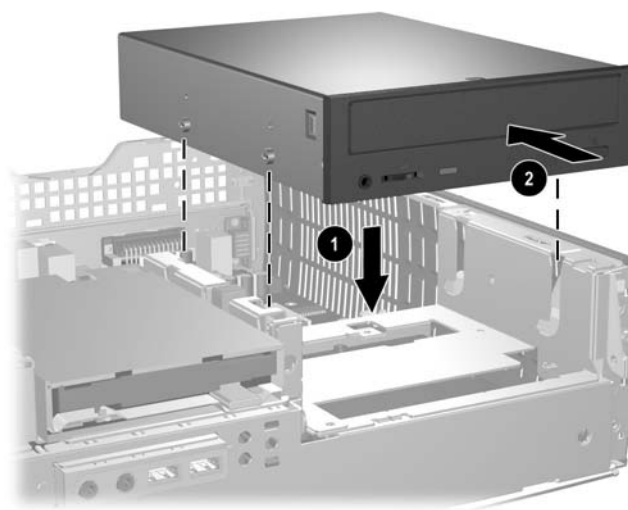

Installing the Optical Drive



The drive release latch automatically locks in place when installing a drive.

4. Raise the Easy Access drive bay to the upright position and connect the flat ribbon cable and audio cable to the system board.

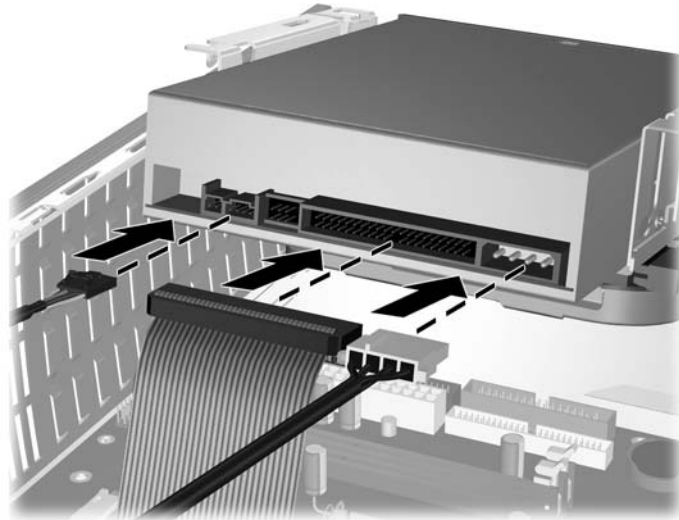

Connecting the Flat Ribbon Cable and Audio Cable

5. Connect the power cable, flat ribbon cable, and audio cable to the rear of the optical drive.



Only Linux systems require an audio cable to be connected to the optical drive.

6. Return the Easy Access drive bay to the down position. Be sure not to pinch the cables in the chassis when lowering the Easy Access drive bay.
7. Replace the front bezel and computer access panel.

The system automatically recognizes the drive and reconfigures the computer.



CAUTION: When servicing the computer, ensure that cables are placed in their proper locations during the reassembly process. Improper cable placement can damage the computer.

6.8.6 Upgrading the Hard Drive - SFF chassis

Removing and Replacing the Hard Drive



Only a serial advanced technology attachment (SATA) hard drive can be installed on this computer.



Make sure to back up the data on the old hard drive before removing it so that you can install the data onto the new hard drive.

The preinstalled 3.5-inch hard drive is located on the right side of the computer. To remove and replace the hard drive:

1. Turn off the computer properly through the operating system, then turn off any external devices.
2. Disconnect the power cord from the power outlet and disconnect any external devices.
3. Remove the computer access panel and front bezel.
4. Raise the Easy Access drive bay to the upright position.
5. Disconnect the power cable and data cable from the back of the drive.

6. Remove the screw ❶.
7. Slide the drive to the right of the bay ❷.

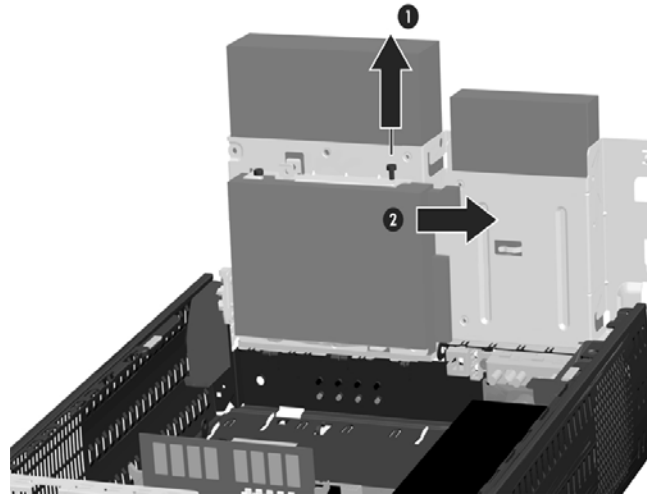

Removing the Hard Drive

8. To install a hard drive, reverse the above procedure.
9. Connect the power cable ❶ and data cable ❷ to the hard drive.

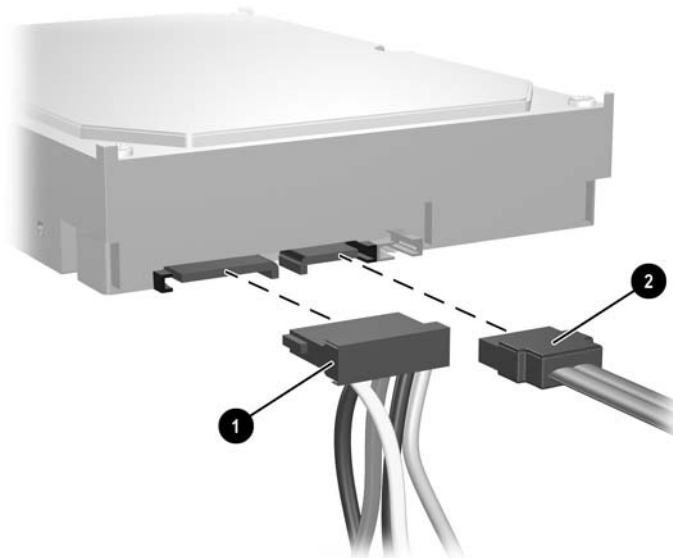

Connecting the Power Cable and Data Cable

6.9 Front I/O Panel Housing Assembly - MT chassis

1. Prepare the computer for disassembly (Section 6.1, “Preparation for Disassembly”).
2. Remove the access panel and rotate the computer so the system board is parallel to the table to make it easier to work on (Section 6.1, “Preparation for Disassembly”).
3. Disconnect two attaching cables from the system board: the power switch/LED cable, and the front USB cable.
4. Remove the two screws ❶ that secure the housing to the chassis and then pull the housing ❷ away from the chassis.

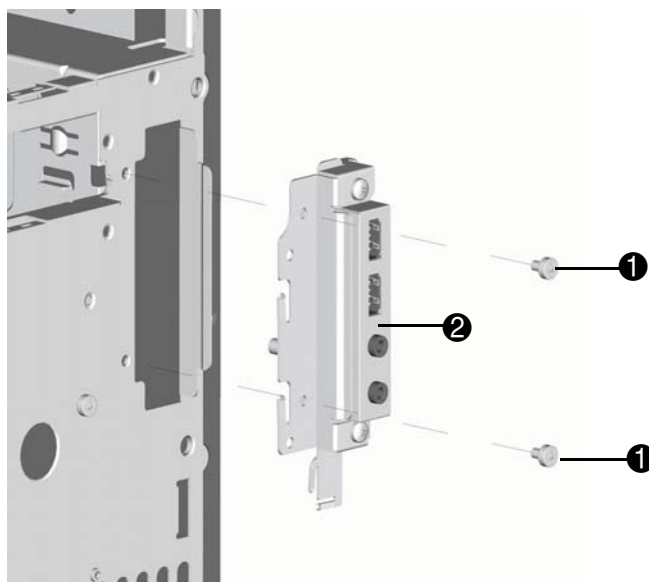

To install the housing assembly, reverse the removal procedures.

The installation method for SFF is similar to MT.

6.10 System Fan

1. Prepare the computer for disassembly (Section 6.1, “Preparation for Disassembly”).
2. Remove the access panel (Section 6.2, “Remove the computer access panel and front bezel (MT chassis and SFF chassis)”).
3. Disconnect the cable that connects the system fan to the system board.
4. Remove the four screws that secure the fan to the chassis and remove the fan.

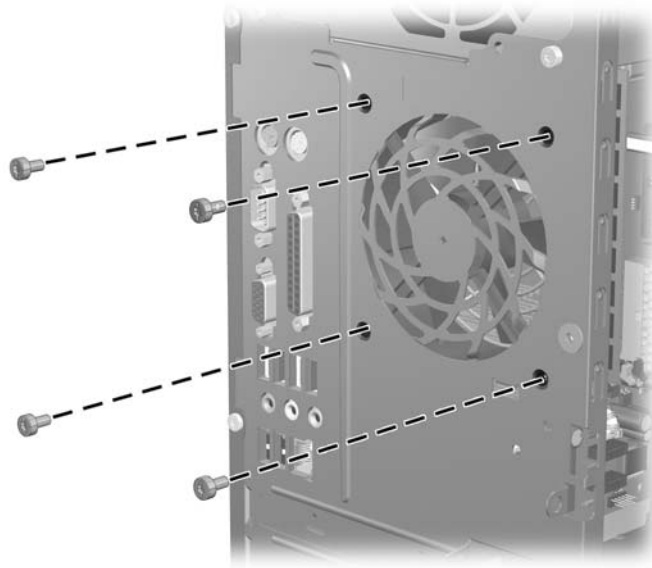

To install the fan, reverse the removal procedures.

Note: Similar installation procedure is lying on SFF for System Fan.

6.11 Heatsink - MT chassis

1. Prepare the computer for disassembly (Section 6.1, “Preparation for Disassembly”).
2. Remove the access panel (Section 6.2, “Remove the computer access panel and front bezel (MT chassis and SFF chassis)”).
3. Lay the computer down on its side to make it easier to work on.
4. Disconnect the 4-pin power cable from the system board to make it easier to access the heatsink.
5. Disconnect the heatsink control cable from the system board.
6. Loosen the four captive screws that secure the heatsink to the system board.
7. Lift the heatsink from atop the processor and set it on its side to keep from contaminating the work area with thermal grease.

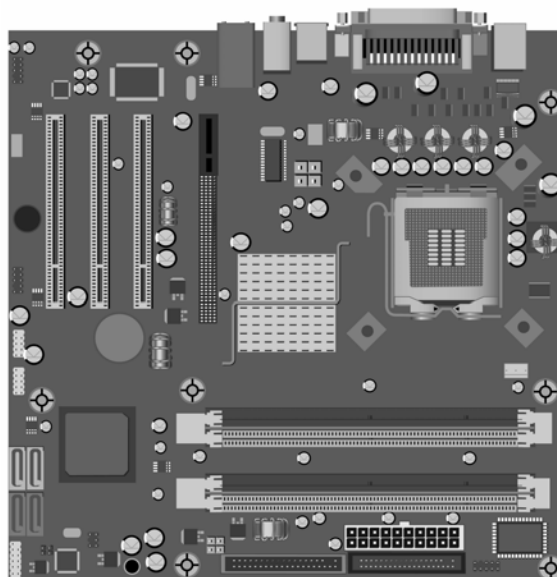

When reinstalling an existing heatsink, make sure that its bottom has been cleaned with an alcohol wipe and fresh thermal grease has been applied to the top of the processor. New heatsinks come from the factory with fresh thermal grease already applied.

Position the heatsink so that fan wiring is closest to the memory module. Check to ensure that the heatsink mounting lugs do not rest on any electrical components before tightening the retaining screws.





CAUTION: Heatsink retaining screws should be tightened in diagonally opposite pairs (as in an X) to evenly seat the heatsink to the processor. This is especially important as the pins on the socket are very fragile and any damage to them may require replacing the system board.

The difference of mounting PCA into chassis between MT and SFF is minor, refer to different shape chassis.

6.12 Processor

1. Prepare the computer for disassembly (Section 6.1, “Preparation for Disassembly”).
2. Remove the access panel cover (Section 6.2, “Remove the computer access panel and front bezel (MT chassis and SFF chassis)”).
3. Disconnect the heatsink control cable from the system board and remove the heatsink. Section 6.11, “Heatsink - MT chassis”
4. Rotate the processor locking lever to its full open position ❶.
5. Raise and rotate the microprocessor retainer to its fully open position ❷.
6. Carefully lift the processor from the socket ❸.

 **CAUTION:** Do NOT handle the pins in the processor socket. These pins are very fragile and handling them could cause irreparable damage. Once pins are damaged it may be necessary to replace the system board.

 **CAUTION:** The heatsink must be installed within 24 hours of installing the processor to prevent damage to the processor’s solder connections.

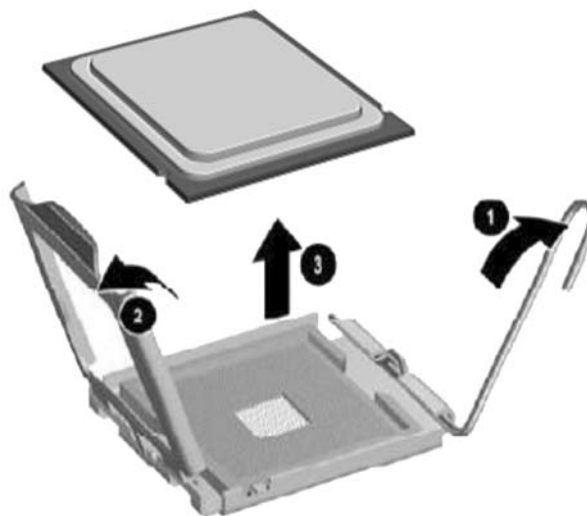

To install a new processor:

1. Place the processor in its socket and close the retainer.
2. Secure the locking lever.

If reusing the existing heatsink, go to step 3.

If using a new heatsink, go to step 6.

3. If reusing the existing heatsink, clean the bottom of the heatsink with the alcohol pad provided in the spares kit.
4. Apply the thermal grease provided in the spares kit to the top of the processor and install the heatsink atop the processor.

5. Go to step 7.
6. If using a new heatsink, remove the protective covering from the bottom of the heatsink and place it in position atop the processor.
7. Secure the heatsink to the system board and system board tray with the 4 captive screws and attach the heatsink control cable to the system board.



CAUTION: Heatsink retaining screws should be tightened in diagonally opposite pairs (as in an X) to evenly seat the heatsink on the processor. This is especially important as the pins on the socket are very fragile and any damage to them may require replacing the system board.



After installing a new processor onto the system board, always update the system ROM to ensure that the latest version of the BIOS is being used on the computer. The latest system ROMPaq can be found on the Web at: <http://h18000.www1.hp.com/support/files>.

6.13 System Board

1. Prepare the computer for disassembly (Section 6.1, “Preparation for Disassembly”).
2. Remove the access panel (Section 6.2, “Remove the computer access panel and front bezel (MT chassis and SFF chassis)”).
3. Remove the front bezel (Section 6.2.2, “Front Bezel (MT Chassis)”).
4. Disconnect the power, and data cables from the back of all installed drives.
5. Disconnect all cables from the system board.
6. Remove the heatsink from the system board (Section 6.11, “Heatsink - MT chassis”).
7. Remove the 6 screws that secure the system board to the chassis.
8. Slide the system board towards the front of the chassis then, angle the back of the board up to remove it.



The system board in the computer may look slightly different from the one shown here.

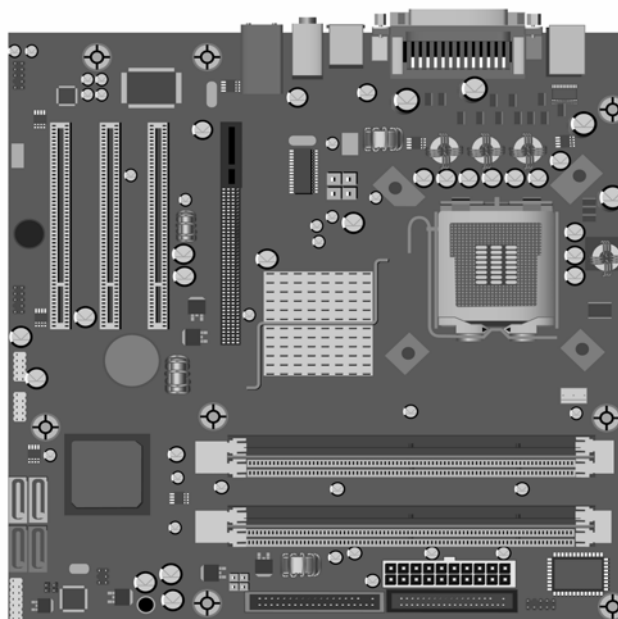

To install the system board, reverse the removal procedure.

The difference of mounting PCA into chassis between MT and SFF is minor, refer to different shape chassis.

6.14 Battery

The battery that comes with your computer provides power to the real-time clock and has a lifetime of about three years. When replacing the battery, use a battery equivalent to the battery originally installed on the computer. The computer comes with a 3-volt lithium coin cell battery.



The lifetime of the lithium battery can be extended by plugging the computer into a live AC wall socket. The lithium battery is only used when the computer is NOT connected to AC power.



WARNING: This computer contains an internal lithium manganese dioxide battery. There is a risk of fire and burns if the battery is not handled properly. To reduce the risk of personal injury:

- Do not attempt to recharge the battery.
- Do not expose to temperatures higher than 140°F (60°C)
- Do not disassemble, crush, puncture, short external contacts, or dispose of in fire or water.
- Replace the battery only with the HP/Compaq spare designated for this product.



CAUTION: Before replacing the battery, it is important to back up the computer CMOS settings. When the battery is removed or replaced, the CMOS settings will be cleared. Refer to the *Troubleshooting Guide* for information on backing up the CMOS settings.



Batteries, battery packs, and accumulators should not be disposed of together with the general household waste. In order to forward them to recycling or proper disposal, please use the public collection system or return them to HP/Compaq, their authorized partners, or their agents.



CAUTION: Static electricity can damage the electronic components of the computer or optional equipment. Before beginning these procedures, ensure that you are discharged of static electricity by briefly touching a grounded metal object.

1. Prepare the computer for disassembly ([Section 6.1, “Preparation for Disassembly”](#)).
2. Remove the right access panel ([Section 6.2, “Remove the computer access panel and front bezel \(MT chassis and SFF chassis\)”](#)).



It may be necessary to remove an expansion card to gain access to the battery.

3. Locate the battery and battery holder on the system board.

6.14.1 Battery Holder

1. To release the battery from its holder, squeeze the metal clamp that extends above one edge of the battery. When the battery pops up, lift it out ❶.
2. To insert the new battery, slide one edge of the replacement battery under the holder's lip with the positive side up ❷. Push the other edge down until the clamp snaps over the other edge of the battery.

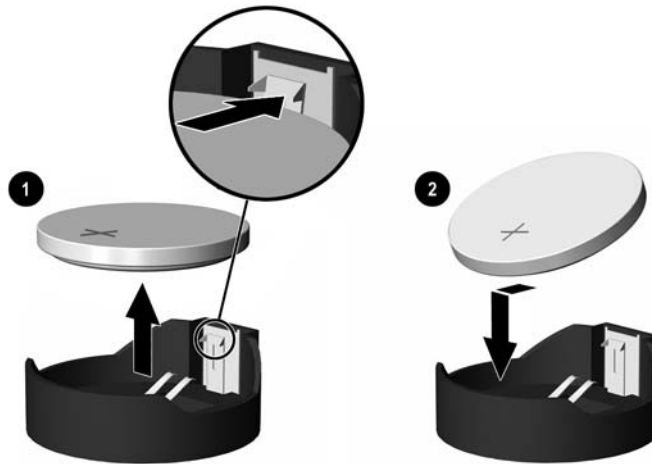

3. Replace the computer access panel.
4. Plug in the computer and turn on power to the computer.
5. Reset the date and time, your passwords, and any special system setups, using Computer Setup. Refer to the *Computer Setup (F10) Utility Guide*.

6.15 Power Supply



WARNING: Voltage is always present on the system board when the computer is plugged into an active AC outlet. To avoid possible personal injury and damage to the equipment the power cord should be disconnected from the computer and/or the AC outlet before opening the computer.

1. Prepare the computer for disassembly (Section 6.1, “Preparation for Disassembly”).
2. Remove the access panel (Section 6.2, “Remove the computer access panel and front bezel (MT chassis and SFF chassis)”).
3. Disconnect all power cables from the mass storage devices and from the system board.
4. Remove the 4 screws ❶ that secure the power supply to the chassis.
5. Slide the power supply toward the front of the computer ❷, then lift it out of the computer.

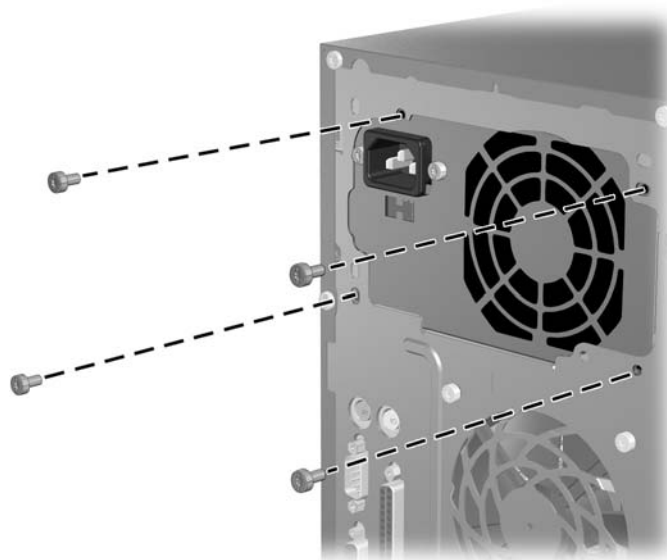

To install the power supply, reverse the removal procedure.

The installation of power supply for MT and SFF is same.

Connector Pin Assignments

This appendix contains the pin assignments for many computer and workstation connectors. Some of these connectors may not be used on the product being serviced.

Enhanced Keyboard

Connector and Icon	Pin	Signal
	1	Data
	2	Unused
	3	Ground
	4	+5 VDC
	5	Clock
	6	Unused

Mouse

Connector and Icon	Pin	Signal
	1	Data
	2	Unused
	3	Ground
	4	+5 VDC
	5	Clock
	6	Unused

Ethernet RJ-45

Connector and Icon	Pin	Signal
	1	(+) Transmit Data
	2	(-) Transmit Data
	3	(+) Receive Data
	4	Unused
	5	Unused
	6	(-) Receive Data
	7	Unused
	8	Unused

Parallel Interface

Connector and Icon

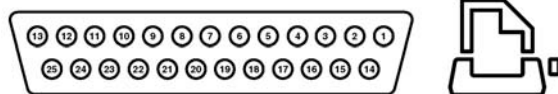

Pin	Signal	Pin	Signal	Pin	Signal
1	Strobe	7	Data Bit 5	13	Select
2	Data Bit 0	8	Data Bit 6	14	Auto Linefeed
3	Data Bit 1	9	Data Bit 7	15	Error
4	Data Bit 2	10	Acknowledge	16	Initialize Printer
5	Data Bit 3	11	Busy	17	Select IN
6	Data Bit 4	12	Paper End	18-25	Signal Ground

Serial Interface, Powered and Non-Powered

Connector and Icon



Pin	Signal
1	Carrier Detect (12V if powered)
2	Receive Data
3	Transmit Data
4	Data Terminal Ready
5	Signal Ground
6	Data Set Ready
7	Request to Send
8	Clear to Send
9	Ring Indicator (5V if powered)

USB

Connector and Icon



Pin	Signal
1	+5 VDC
2	- Data
3	+ Data
4	Ground

Microphone

Connector and Icon (1/8" miniphone)

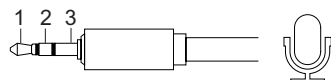

Pin	Signal
1 (Tip)	Audio
2 (Ring)	Power
3 (Shield)	Ground

Headphone

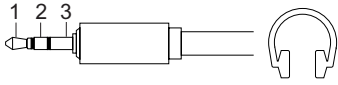
Connector and Icon (1/8" miniphone)	Pin	Signal
	1 (Tip)	Audio_Left
	2 (Ring)	Audio_Right
	3 (Shield)	Ground

Line-In Audio

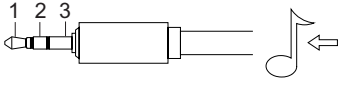
Connector and Icon (1/8" miniphone)	Pin	Signal
	1 (Tip)	Audio_In_Left
	2 (Ring)	Audio_In_Right
	3 (Shield)	Ground

Line-Out Audio

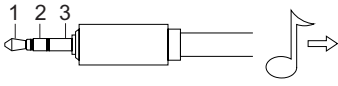
Connector and Icon (1/8" miniphone)	Pin	Signal
	1 (Tip)	Audio_Out_Left
	2 (Ring)	Audio_Out_Right
	3 (Shield)	Ground

Monitor

Connector and Icon

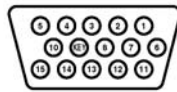

Pin	Signal	Pin	Signal	Pin	Signal
1	Red Analog	6	Ground	11	Not used
2	Green Analog	7	Ground	12	DDC Serial Data
3	Blue Analog	8	Ground	13	Horizontal Sync
4	Not used	9	+5V DC (fused)	14	Vertical Sync
5	Ground	10	Ground	15	DDC Serial Clock

24-Pin Power

Connector

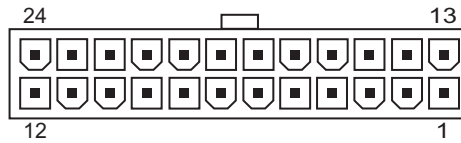

Pin	Signal	Pin	Signal	Pin	Signal	Pin	Signal
1	+3.3 V	8	P.G	14	-12 V	21	+5 V
2	+3.3 V	9	+5 VSB	15	GND	22	+5 V
3	GND	10	+12 V	16	PSON	23	+5 V
4	+5 V	11	+12 V	17	GND	24	GND
5	GND	12	+3.3 V	18	GND		
6	+5 V	13	+3.3 V	19	GND		
7	GND	13-1	+3.3 VS	20	NI		

4-Pin Power (for CPU)

Connector and Icon	Pin	Signal
	1	GND
	2	GND
	3	+12 V
	4	+12 V

Power Cord Set Requirements

The voltage select switch feature on the computer permits it to operate from any line voltage between 100-127 or 220-240 volts AC (230V-China only). (a) When dx2700 MT/dx2708 MT/dx2700 SFF are assembled and shipped only for China, or Korea, or Australia/New Zealand Market, there aren't power switch selector with installed power supply. (b) When dx2700 MT and dx2700 SFF are intended to be assembled and sold for Non-China region (exclusive above countries mentioned on (a)), there are power switch selector with installed power supply.

The power cord set received with the computer meets the requirements for use in the country where you purchased the equipment.

Power cord sets for use in other countries must meet the requirements of the country where you use the computer. For more information on power cord set requirements, contact your authorized HP dealer, reseller, or service provider.

General Requirements

The requirements listed below are applicable to all countries:

1. The length of the power cord set must be at least 1.8 m (6.00 feet) and a maximum of 3.0 m (9.75 feet.)
2. All power cord sets must be approved by an acceptable accredited agency responsible for evaluation in the country where the power cord set will be used.
3. The power cord set must have a minimum current capacity of 10A and a nominal voltage rating of 115 to 230 volts AC, as required by each country's power system.
4. The appliance coupler must meet the mechanical configuration of an EN 60 320/IEC 320 Standard Sheet C13 connector, for mating with appliance inlet on the Switch Box.

POST Error Messages

An error message results if the Power-On Self-Test (POST) encounters a problem. This test runs when the system is turned on, checking assemblies within the computer and reporting any errors found.

Not all computers use all of the codes listed.

Recommended Actions are to be taken in incremental steps. Perform one step at a time and continue only if the action does not cure the problem.

POST Error Messages

Screen Message	Probable Cause	Recommended Action
Gate 20 Error	BIOS cannot access memory over 1MB.	Reseat memory modules. Replace memory modules.
Parity Error	Fatal memory parity error. System halts after displaying this message.	Reseat memory modules. Replace memory modules.
Boot Failure...	BIOS could not boot from the device. This message is usually followed by information about the specific device.	Reseat the device data and power cables. Replace the device data cable. Replace the device. Replace the system board.
Invalid Boot Diskette	Diskette in drive A: not bootable.	Replace the diskette.
Drive Not Ready	BIOS could not configure drive A: during POST.	Reseat the device data and power cables. Replace the device data cable. Replace the device. Replace the system board.
Drive A: Error	BIOS could not configure drive A: during POST.	Reseat the device data and power cables. Replace the device data cable. Replace the device. Replace the system board.
Insert BOOT Diskette In A:	BIOS could not find a bootable diskette in drive A:.	Replace the diskette.

POST Error Messages

Screen Message	Probable Cause	Recommended Action
Primary Master/Slave Hard Disk Error	Primary Master/Slave hard drive could not be initialized by the BIOS.	Reseat the device data and power cables. Replace the device data cable. Replace the device. Replace the system board.
Secondary Master/ Slave Hard Disk Error	Secondary Master/Slave hard drive could not be initialized by the BIOS.	Reseat the device data and power cables. Replace the device data cable. Replace the device. Replace the system board.
Primary Master/Slave Drive — ATAPI Incompatible	Device configured as a Primary/ Master/Slave failed an ATAPI compatibility test.	Replace the device. Replace the system board.
Secondary Master/ Slave Drive — ATAPI Incompatible	Device configured as a Secondary/ Master/ Slave failed an ATAPI compatibility test.	Replace the device. Replace the system board.
S.M.A.R.T. Capable but Command Failed. S.M.A.R.T. Command Failed	BIOS unable to send a S.M.A.R.T. message to the device.	Backup the data on the hard drive. Replace the hard drive.
S.M.A.R.T. Status Bad, Backup and replace. S.M.A.R.T. Capable and Status Bad.	S.M.A.R.T. capable hard drive detects an imminent failure.	Backup the data on the hard drive, then replace the hard drive.
DMA-1 Error DMA-2 Error	Error when initializing secondary DMA controller.	Reconnect the cables on the peripheral device. Replace the data cable. Replace the device. Replace the system board.
DMA Controller Error	POST error while trying to initialize the DMA controller.	Reconnect the cables on the peripheral device. Replace the data cable. Replace the device. Replace the system board.
Checking NVRAM...Update Failed	BIOS could not write to the NVRAM block.	Change system board jumper on JP2 to pins 2-3 (Unlock), then flash the system BIOS. Reset the jumper to pins 1-2 (Lock). Replace the system board.

POST Error Messages

Screen Message	Probable Cause	Recommended Action
Microcode Error	BIOS could not find or load the CPU microcode update to the CPU.	Ensure the system board BIOS supports the processor. Change system board jumper on JP2 to pins 2-3 (Unlock), then flash the system BIOS. Reset the jumper to pins 1-2 (Lock).
NVRAM Checksum Bad, NVRAM Cleared	Error detected while validating NVRAM data.	Restart the computer, use the F10 Key to access Computer Setup. Select Load Default Settings > Save and Exit .
NVRAM Ignored	NVRAM data used to store plug and play data was not used for system configuration in POST.	Restart the computer, use the F10 Key to access Computer Setup. Select Load Default Settings > Save and Exit . Change system board jumper on JP2 to pins 2-3 (Unlock), then flash the system BIOS. Reset the jumper to pins 1-2 (Lock). Replace the system board.
NVRAM Bad	NVRAM data used to store plug and play data was not used for system configuration in POST.	Restart the computer, use the F10 Key to access Computer Setup. Select Load Default Settings > Save and Exit . Change system board jumper on JP2 to pins 2-3 (Unlock), then flash the system BIOS. Reset the jumper to pins 1-2 (Lock). Replace the system board.
Timer Error	Error found while programming the count register of channel 2 of the 8254 timer.	Replace the system board.
Interrupt Controller-1 Error Interrupt Controller-1 Error	BIOS POST could not initialize the Master/Slave Interrupt controller.	Replace the system board.
CMOS Date/Time Not Set	CMOS Date and/or Time is invalid.	Set the date and time under Control Panel or in F10 Setup depending on the operating system. If problem persists, replace the RTC battery.
CMOS Battery Low	CMOS battery weak.	Replace the RTC battery.
CMOS Settings Wrong	Invalid CMOS settings.	Restart the computer, use the F10 Key to access Computer Setup. Select Load Default Settings > Save and Exit .

POST Error Messages

Screen Message	Probable Cause	Recommended Action
CMOS Checksum Bad	CMOS contents failed the Checksum check.	Restart the computer, use the F10 Key to access Computer Setup. Select Load Default Settings > Save and Exit.
Keyboard Error	Keyboard not present or system not responding when keyboard controller is initialized.	Reconnect keyboard with computer turned off. Check connector for bent or missing pins. Ensure that none of the keys are depressed. Replace keyboard. Replace system board.
Keyboard/Interface Error	Keyboard controller failure.	Reconnect keyboard with computer turned off. Check connector for bent or missing pins. Ensure that none of the keys are depressed. Replace keyboard. Replace system board.

Troubleshooting Without Diagnostics

Preliminary Checklist

This section describes some simple, preliminary tests and guidelines for troubleshooting the computer without using the diagnostics.

- Are the computer and monitor connected to a working electrical outlet?
- Is the voltage select switch is set to the appropriate voltage for your region (115V or 230V)?
- Is the computer turned on?
- Is the green power light illuminated?
- Is the monitor turned on?
- Is the green monitor light illuminated?
- Turn up the monitor brightness and contrast controls if the monitor is dim.
- If the system has multiple video sources (embedded, PCI, or AGP adapters) installed (embedded video on select models only) and a single monitor, the monitor must be plugged into the monitor connector on the source selected as the primary VGA adapter. During boot, the other monitor connectors are disabled and if the monitor is connected into these ports, the monitor will not function. You can select which source will be the default VGA source in Computer (F10) Setup.
- Press and hold any key. If the system beeps, then the keyboard is operating correctly.
- Check all cables for loose or incorrect connections.
- Reconfigure the computer after installing a non-Plug and Play expansion board or other option, such as a diskette drive.
- Are all of the necessary device drivers installed?
- Have all printer drivers been installed for each application?
- Remove all diskettes from the diskette drives before you turn on the system.
- Are all switches set correctly?
- Is the NIC Remote Wakeup cable (featured on some models) connected between the NIC and the riser/system board?

Solving General Problems

You may be able to easily resolve the minor problems described in this section. If a problem persists and you are unable to resolve it yourself or if you feel uncomfortable about performing the operation, contact your HP authorized reseller or service provider.

Problem	Cause	Solution
Computer will not turn on.	Cables to the external power source are unplugged.	Ensure that cables connecting the computer to the external power source are plugged in properly and the wall outlet is active.
	Voltage selector switch* on the rear of the computer chassis is not switched to the correct voltage (115V or 230V).	Select the proper AC voltage using the slide switch.
	A defective PCI card has been installed.	Remove any expansion board that was just installed.
	Drive data or power supply cables may not be properly connected.	Reseat drive data and power supply cables.
	The unit temperature was exceeded. The fan may be blocked.	<ol style="list-style-type: none"> 1. Unit is in an exceedingly hot environment. Let it cool down. 2. Ensure that computer air vents are not blocked and the internal fan is running. 3. Contact an HP authorized reseller or service provider.
Computer appears locked up and will not turn off when the power button is pressed.	Software control of the power switch is not functional.	<ol style="list-style-type: none"> 1. Press and hold the power button for at least four seconds until the computer turns off. 2. Disconnect the power cord from the electrical outlet.
Computer will not respond to USB keyboard or mouse.	Computer is in standby mode.	Press the power button to resume from standby mode.
	Keyboard or mouse is not connected to computer.	Connect keyboard and mouse cables to computer.
	System has locked up.	Restart the computer.

 **CAUTION:** When attempting to resume from **standby** mode, do not hold down the power button for more than four seconds. Otherwise, the computer will shut down and you will lose any unsaved data.

* Applicable for non China version.

Problem	Cause	Solution
Computer date and time display is incorrect.	<p>RTC (real-time clock) battery may need to be replaced.</p> <p> MConnecting the computer to a live AC outlet prolongs the life of the RTC battery.</p>	<p>First, reset the Date and Time Properties in the Control Panel (Computer Setup can also be used to update the RTC date and time). If the problem persists, replace the RTC battery. See the <i>Hardware Reference Guide</i> on the <i>Library CD</i> for instructions on installing a new battery.</p>
Cursor will not move using the arrow keys on the keypad.	The Num Lock key may be on.	<p>Press the Num Lock key. The Num Lock light should not be on if you want to use the arrow keys. The Num Lock key can be disabled (or enabled) in Computer Setup.</p>
Poor performance is experienced.	Processor is hot.	<ol style="list-style-type: none"> 1. Ensure airflow to the computer is not blocked. Leave a 4-inch (10.2-cm) clearance on all vented sides of the computer and monitor to permit required airflow. 2. Ensure fans are connected and working properly (some fans only operate when needed). 3. Ensure the processor heatsink is installed properly.
Poor performance is experienced (<i>continued</i>).	Hard drive is full.	Transfer data from the hard drive to create more space on the hard drive.
	Low on memory.	Add more memory.
	Hard drive is fragmented.	Defragment hard drive.
	Program previously accessed did not release reserved memory back to the system.	Restart the computer.
	Virus resident on the hard drive.	Run the virus protection program.
	Too many applications running.	<ol style="list-style-type: none"> 1. Close unnecessary applications to free up memory. 2. Add more memory.

Problem	Cause	Solution
	Some software applications, especially games, are stressful on the graphics subsystem.	<ol style="list-style-type: none"> 1. Lower the display resolution for the current application or consult the documentation that came with the application for suggestions on how to improve performance by adjusting parameters in the application. 2. Add more memory. 3. Upgrade the graphics solution.
	Cause unknown.	Restart the computer.
Blank screen (no video).	Monitor is not turned on and the monitor light is not on.	Turn on the monitor and check that the monitor light is on.
	The cable connections are not correct.	Check the cable connection from the monitor to the computer and to the electrical outlet.
Blank screen (no video) <i>(continued)</i> .	You may have a screen blanking utility installed or energy saver features are enabled.	Press any key or click the mouse button and, if set, type your password.
	Computer is in standby mode.	Press the power button to resume from standby mode.
<p> CAUTION: When attempting to resume from standby mode, do not hold down the power button for more than four seconds. Otherwise, the computer will shut down and you will lose any unsaved data.</p>		
	You are using a fixed-sync monitor and it will not sync at the resolution chosen.	Be sure that the monitor can accept the same horizontal scan rate as the resolution chosen.
	The VGA/BNC selector switch on the monitor (some models) is not properly set.	Set the selector switch to agree with the cable connection.
	Bad monitor.	Try a different monitor.
Power LED is flashing and computer will not start.	Internal error has occurred and the computer is flashing a code.	Refer to “Interpreting Diagnostic Lights and Audible Codes” to interpret the error code.

Solving Hardware Installation Problems

You may need to reconfigure the computer when you add or remove hardware, such as an additional drive or expansion card. If you install a plug and play device, Windows XP Home/Professional will automatically recognize the device and configure the computer. If you install a non-plug and play device, you must reconfigure the computer after completing installation of the new hardware. In Windows XP Home/Professional, use the **Add Hardware Wizard** and follow the instructions that appear on the screen.

Problem	Cause	Solution
A new device is not recognized as part of the system.	Device is not seated or connected properly.	Ensure that the device is properly and securely connected and that pins in the connector are not bent down.
	Cable(s) of new external device are loose or power cables are unplugged.	Ensure that all cables are properly and securely connected and that pins in the cable or connector are not bent down.
	Power switch of new external device is not turned on.	Turn off the computer, turn on the external device, then turn on the computer to integrate the device with the computer system.
	When the system advised you of changes to the configuration, you did not accept them.	Reboot the computer and follow the instructions for accepting the changes.
	A plug and play board may not automatically configure when added if the default configuration conflicts with other devices.	Use Windows XP Device Manager to deselect the automatic settings for the board and choose a basic configuration that does not cause a resource conflict. You can also use Computer Setup to reconfigure or disable devices to resolve the resource conflict.
Computer will not start.	Wrong memory modules were used in the upgrade or memory modules were installed in the wrong location.	<ol style="list-style-type: none"> 1. Review the documentation that came with the system to determine if you are using the correct memory modules and to verify the proper installation. 2. Observe the beeps and LED lights on the front of the computer. See "Interpreting Diagnostic Lights and Audible Codes" to determine possible causes. 3. If you still cannot resolve the issue, contact Customer Support.

Interpreting Diagnostic Lights and Audible Codes

This section covers the front panel LED codes as well as the audible codes that may occur before or during POST that do not necessarily have an error code or text message associated with them.



If you see flashing LEDs on a PS/2 keyboard, look for flashing LEDs on the front panel of the computer and refer to the following table to determine the front panel LED codes.



Recommended actions in the following table are listed in the order in which they should be performed.



Replace the system board or power supply only as the last resort.

Solving Display Problems

Solving Display Problems		
Problem	Cause	Solution
Blank screen (no video).	The cable connections are not correct.	Check the cable connections from the monitor to the computer and to the electrical outlet.
	Screen blanking utility installed or energy saver features enabled.	Press any key or click the mouse button and, if set, type your password.
	System ROM is bad; system is running in FailSafe Boot Block mode (indicated by eight beeps).	Reflash the ROM using a ROMPaq diskette.
	Fixed-sync monitor will not sync at the resolution chosen.	Ensure that the monitor can accept the same horizontal scan rate as the resolution chosen.
	Computer is in standby mode.	Press the power button to resume from standby mode.
<p> CAUTION: When attempting to resume from standby mode, do not hold down the power button for more than four seconds. Otherwise, the computer will shut down and you will lose your data.</p>		
	Monitor cable plugged into the wrong connector.	If the computer system has both an integrated graphics connector and an AGP card connector, plug the monitor cable into the AGP card connector.
	Monitor settings in the computer are not compatible with the monitor.	<ol style="list-style-type: none"> 1. Restart the computer and press F8 during startup when you see "Press F8" in the bottom right corner of the screen. 2. Using the keyboard arrow keys, select Enable VGA Mode and press Enter. 3. In Windows Control Panel, double-click the Display icon and select the Settings tab. 4. Use the sliding control to reset the resolution.

Solving Display Problems (Continued)

Problem	Cause	Solution
Power LED flashes Red six times, once every second, followed by a two second pause, and the computer beeps six times.	Pre-video graphics error.	For systems with a graphics card: <ol style="list-style-type: none"> 1. Reseat the graphics card. 2. Replace the graphics card. 3. Replace the system board. For systems with integrated graphics, replace the system board.
Monitor does not function properly when used with energy saver features.	Monitor without energy saver capabilities is being used with energy saver features enabled.	Disable monitor energy saver feature.
Dim characters.	The brightness and contrast controls are not set properly.	Adjust the monitor brightness and contrast controls.
	Cables are not properly connected.	Check that the graphics cable is securely connected to the graphics card and the monitor.
Blurry video or requested resolution cannot be set.	If the graphics controller was upgraded, the correct video drivers may not be loaded.	Install the video drivers included in the upgrade kit.
	Monitor is not capable of displaying requested resolution.	Change requested resolution.
The picture is broken up, rolls, jitters, or flashes.	The monitor connections may be incomplete or the monitor may be incorrectly adjusted.	<ol style="list-style-type: none"> 1. Be sure the monitor cable is securely connected to the computer. 2. In a two-monitor system or if another monitor is in close proximity, be sure the monitors are not interfering with each other's electromagnetic field by moving them apart. 3. Fluorescent lights or fans may be too close to the monitor.
	Monitor needs to be degaussed.	Degauss the monitor.
Vibrating or rattling noise coming from inside a CRT monitor when powered on.	Monitor degaussing coil has been activated.	None. It is normal for the degaussing coil to be activated when the monitor is powered on.
Clicking noise coming from inside a CRT monitor.	Electronic relays have been activated inside the monitor.	None. It is normal for some monitors to make a clicking noise when turned on and off, when going in and out of standby mode, and when changing resolutions.

Solving Display Problems (Continued)

Problem	Cause	Solution
High pitched noise coming from inside a flat panel monitor.	Brightness and/or contrast settings are too high.	Lower brightness and/or contrast settings.
Fuzzy focus; streaking, ghosting, or shadowing effects; horizontal scrolling lines; faint vertical bars; or unable to center the picture on the screen. (flat panel monitors using an analog VGA input connection only)	Flat panel monitor's internal digital conversion circuits may be unable to correctly interpret the output synchronization of the graphics card.	<ol style="list-style-type: none"> 1. Select the monitor's Auto-Adjustment option in the monitor's on-screen display menu. 2. Manually synchronize the Clock and Clock Phase on-screen display functions. Download SoftPaq SP20930 or SP22333, depending on the monitor, to assist with the synchronization. <p>NOTE: Use the monitor model number when searching for the SoftPaq.</p>
Certain typed symbols do not appear correct.	The font you are using does not support that particular symbol.	Use the Character Map to locate the and select the appropriate symbol. Click Start > All Programs > Accessories > System Tools > Character Map . You can copy the symbol from the Character Map into a document.

Solving Audio Problems

Solving Audio Problems

Problem	Cause	Solution
Sound does not come out of the speaker or headphones.	Software volume control is turned down.	Double-click the Speaker icon on the taskbar and use the volume slider to adjust the volume.
	The external speakers are not turned on.	Turn on the external speakers.
	External speakers plugged into the wrong audio jack.	See the sound card documentation for proper speaker connection.
	Audio cable not connected.	Connect audio cable between CD or DVD-ROM drive and the system board.
	Digital CD audio is not enabled.	Enable digital CD audio: <ol style="list-style-type: none"> 1. From the Control Panel, select System. 2. On the Hardware tab, click the Device Manager button. 3. Right-click on the CD/DVD device and select Properties. 4. On the Properties tab, make sure "Enable digital CD audio for this CD-ROM device" is checked.
Headphones or devices connected to the line-out connector mute the internal speaker.	Turn on and use headphones or external speakers, if connected, or disconnect headphones or external speakers.	
Volume is muted.	<ol style="list-style-type: none"> 1. From the Control Panel program, click Sound, Speech and Audio Devices, then click Sounds and Audio Devices. 2. Click the Mute check box to remove the check mark from the box. 	
Computer is in standby mode.	Press the power button to resume from standby mode.	

 **CAUTION:** When attempting to resume from **standby** mode, do not hold down the power button for more than four seconds. Otherwise, the computer will shut down and you will lose your data.



Solving Audio Problems (Continued)

Problem	Cause	Solution
Noise or no sound comes out of the speakers or headphones.		<ol style="list-style-type: none"> 1. If using digital speakers that have a stereo jack and want the system to auto-switch to digital, use a stereo-to-mono adapter to properly engage the auto-sense feature or use the multimedia device properties to manually switch the audio signal from analog to digital. 2. If the headphones have a mono jack, use the multimedia device properties to switch the system to analog out.
<p> If you set digital as the Output Mode, the internal speaker and external analog speakers will no longer output audio until you switch back to an auto-sense or analog mode.</p> <p>If you set analog as the Output Mode, external digital speakers will not function until you change the output mode back to an auto-sense or digital mode.</p>		
Sound cuts in and out.	Processor resources are being used by other open applications.	Shut down all open processor-intensive applications.
Computer appears to be locked up while recording audio.	The hard disk may be full.	<ol style="list-style-type: none"> 1. Before recording, make sure there is enough free space on the hard disk. 2. Try recording the audio file in a compressed format.

Solving Printer Problems

Solving Printer Problems		
Problem	Cause	Solution
Printer will not print.	Printer is not turned on and online.	Turn the printer on and make sure it is online.
	The correct printer driver for the application are not installed.	<ol style="list-style-type: none"> 1. Install the correct printer driver for the application. 2. Try printing using the MS-DOS command: DIR C:\ > [printer port] where [printer port] is the address of the printer being used. If the printer works, reload the printer driver.
	If you are on a network, you may not have made the connection to the printer.	Make the proper network connections to the printer.
	Printer may have failed.	Run printer self-test.
Printer will not turn on.	The cables may not be connected properly.	Reconnect all cables.
Printer prints garbled information.	The correct printer driver is not installed.	Install the correct printer driver for the application.
	The cables may not be connected properly.	Reconnect all cables.
	Printer memory may be overloaded.	Reset the printer by turning it off for one minute, then turn it back on.
Printer is offline.	The printer may be out of paper.	<ol style="list-style-type: none"> 1. Check the paper tray and refill it if it is empty. 2. Select online.

Solving Keyboard and Mouse Problems

Solving Keyboard Problems		
Problem	Cause	Solution
Keyboard commands and typing are not recognized by the computer.	Keyboard connector is not properly connected.	<ol style="list-style-type: none"> 1. Turn off the computer. 2. Reconnect the keyboard to the back of the computer and restart the computer.
	Program in use has stopped responding to commands.	Shut down the computer using the mouse and then restart the computer.
	Keyboard needs repairs.	Replace the keyboard.
	Computer is in standby mode.	Press the power button to resume from standby mode.
<p> CAUTION: When attempting to resume from standby mode, do not hold down the power button for more than four seconds. Otherwise, the computer will shut down and you will lose your data.</p>		
Cursor will not move using the arrow keys on the keypad.	The Num Lock key may be on.	Press the Num Lock key. The Num Lock light should not be on if you want to use the arrow keys. The Num Lock key can be disabled (or enabled) in Computer Setup.
Mouse does not respond to movement or is too slow.	Mouse connector is not properly plugged into the back of the computer.	<ol style="list-style-type: none"> 1. Shut down the computer using the keyboard. 2. Plug the mouse connector into the back of the computer (or the keyboard) and restart the computer.
	Program in use has stopped responding to commands.	Shut down the computer using the keyboard and then restart the computer.
	Mouse needs repairs.	Replace the mouse.
	Computer is in standby mode.	Press the power button to resume from standby mode.
<p> CAUTION: When attempting to resume from standby mode, do not hold down the power button for more than four seconds. Otherwise, the computer will shut down and you will lose your data.</p>		
Mouse will only move vertically or horizontally, or movement is jerky.	Mouse roller ball is dirty.	Remove roller ball cover from the bottom of the mouse and clean it.

Solving Network Problems

These guidelines do not discuss the process of debugging the network cabling.

Solving Network Problems

Problem	Cause	Solution
Wake-on-LAN feature is not functioning.	Wake-on-LAN is not enabled.	Use the Network control application to enable Wake-on-LAN.
Network driver does not detect network controller.	Network controller is disabled.	Run Computer Setup and enable network controller.
	Incorrect network driver.	Check the network controller documentation for the correct driver or obtain the latest driver from the manufacturer's Web site.
<p>Network status link light does not turn on or it never flashes.</p> <p> The network status light should flash when there is network activity.</p>	No active network is detected.	Check cabling and network equipment for proper connection.
	Network controller is not set up properly.	Use the Network control application to verify that the device is working properly.
	Network driver is not properly loaded.	Reinstall network drivers.
	System cannot autosense the network.	Disable auto-sensing capabilities and force the system into the correct operating mode.
Diagnostics reports a failure.	The cable is not securely connected.	Ensure that both ends of the data cable are securely connected.
	The cable is attached to the incorrect connector.	Ensure that the cable is attached to the correct connector.
	There is a problem with the cable or a device at the other end of the cable.	Ensure that the cable and device at the other end are operating correctly.
	Network controller interrupt is shared with an expansion board.	Under the Computer Setup Advanced menu, change the resource settings for the board.
	The network controller is defective.	Replace the NIC or replace the system board if the NIC is embedded.
Diagnostics passes, but the computer does not communicate with the network.	Network drivers are not loaded, or driver parameters do not match current configuration.	<ol style="list-style-type: none"> 1. Make sure the network drivers are loaded and that the driver parameters match the configuration of the network controller. 2. Make sure the correct network client and protocol is installed.

Solving Network Problems *(Continued)*

Problem	Cause	Solution
Diagnosics passes, but the computer does not communicate with the network. (continued)	The network controller is not configured for this computer.	Select the Network icon in the Control Panel and configure the network controller.
Network controller stopped working when an expansion board was added to the computer.	Network controller interrupt is shared with an expansion board.	Under the Computer Setup Advanced menu, change the resource settings for the board.
	The network controller requires drivers.	Verify that the drivers were not accidentally deleted when the drivers for a new expansion board were installed.
	The expansion board installed is a network card (NIC) and conflicts with the embedded NIC.	Under the Computer Setup Advanced menu, change the resource settings for the board.
Network controller stops working without apparent cause.	The files containing the network drivers are corrupted.	Reinstall the network drivers, using the <i>Restore Plus!</i> CD.
	The cable is not securely connected.	Ensure that both ends of the cable are securely attached to the correct devices.
	The network controller is defective.	Replace the NIC or replace the system board if the NIC is embedded.
New network card will not boot.	New network card may be defective or may not meet industry-standard specifications.	Install a working, industry-standard NIC, or change the boot sequence to boot from another source.
Cannot connect to network server when attempting Remote System Installation.	The network controller is not configured properly.	Verify Network Connectivity, that a DHCP Server is present, and that the Remote System Installation Server contains the NIC drivers for your NIC.
System setup utility reports unprogrammed EEPROM.	Unprogrammed EEPROM.	Flash the ROM.

Solving Memory Problems

 **CAUTION:** For those systems that support ECC memory, HP does not support mixing ECC and non-ECC memory. Otherwise, the system will not boot the operating system.

Solving Memory Problems

Problem	Cause	Solution
System will not boot or does not function properly after installing additional memory modules.	Memory module is not the correct type or speed or the new memory module is not seated properly.	Replace module with the correct industry-standard device for the computer.
		ECC memory modules are not supported.
Out of memory error.	Memory configuration may not be set up correctly.	Use the Device Manager to check memory configuration.
	You have run out of memory to run the application.	Check the application documentation to determine the memory requirements.
Memory count during POST is wrong.	The memory modules may not be installed correctly.	Check that the memory modules have been installed correctly and that proper modules are used.
Insufficient memory error during operation.	Too many Terminate and Stay Resident programs (TSRs) are installed.	Delete any TSRs that you do not need.
	You have run out of memory for the application.	Check the memory requirements for the application or add more memory to the computer.
Power LED flashes GREEN five times, once every second, followed by a two second pause. Also, five simultaneous beeps will be heard.	Memory is installed incorrectly or is bad.	<ol style="list-style-type: none"> 1. Reseat DIMMs. 2. Replace DIMMs one at a time to isolate the faulty module. 3. Replace third-party memory with HP memory. 4. Replace the system board.

Solving Processor Problems

Solving Processor Problems

Problem	Cause	Solution
Poor performance is experienced.	Processor is hot.	<ol style="list-style-type: none"> 1. Make sure the airflow to the computer is not blocked. 2. Make sure the fans are connected and working properly (some fans only operate when needed). 3. Make sure the processor heatsink is installed properly.

Solving CD-ROM and DVD Problems

Solving CD-ROM and DVD Problems		
Problem	Cause	Solution
System will not boot from CD-ROM or DVD drive.	The CD-ROM or DVD boot is not enabled through the Computer Setup utility.	Run the Computer Setup utility and enable booting to removable media and verify boot order settings.
	Non-bootable CD in drive.	Try a bootable CD in the drive.
CD-ROM or DVD devices are not detected or driver is not loaded.	Drive is not connected properly or not properly configured.	<ol style="list-style-type: none"> 1. Reconnect power and data cables to the drive. 2. Install correct device driver.
Movie will not play in the DVD drive.	Movie may be regionalized for a different country.	See the documentation that came with the DVD drive.
	Decoder software is not installed.	Install decoder software.
Cannot eject compact disc (tray-load unit).	Disc not properly seated in the drive.	<ol style="list-style-type: none"> 1. Turn off the computer and insert a thin metal rod into the emergency eject hole and push firmly. 2. Slowly pull the tray out from the drive until the tray is fully extended, then remove the disc.
CD-ROM, CD-RW, DVD-ROM, or DVD-R/RW drive cannot read a disc or takes too long to start.	CD has been inserted upside down.	Re-insert the CD with the label facing up.
	The DVD-ROM drive takes longer to start because it has to determine the type of media played, such as audio or video.	Wait at least 30 seconds to let the DVD-ROM drive determine the type of media being played. If the disc still does not start, read the other solutions listed for this topic.
	CD or DVD disc is dirty.	Clean CD or DVD with a CD cleaning kit.
	Windows does not detect the CD-ROM or DVD-ROM drive.	<ol style="list-style-type: none"> 1. Use Device Manager to remove or uninstall the device in question. 2. Restart the computer and let Windows detect the device.

Solving CD-ROM and DVD Problems *(Continued)*

Problem	Cause	Solution
Recording audio CDs is difficult or impossible.	Wrong or poor quality media type.	<ol style="list-style-type: none"> 1. Try using a slower recording speed. 2. Verify that you are using the correct media for the drive. 3. Try a different brand of media. Quality varies widely between manufacturers.

Solving Drive Key Problems

Solving DiskOnKey Problems

Problem	Cause	Solution
Drive Key is not seen as a drive letter in Windows XP.	The drive letter after the last physical drive is not available.	Change the default drive letter for the Drive Key in Windows XP.
The computer boots to DOS after making a bootable Drive Key.	Drive Key is bootable.	Install the Drive Key after the operating system boots.

Solving Internet Access Problems

Solving Internet Access Problems

Problem	Cause	Solution
Unable to connect to the Internet.	Internet Service Provider (ISP) account is not set up properly.	Verify Internet settings or contact the ISP for assistance.
	Modem is not set up properly.	Reconnect the modem. Verify the connections are correct using the quick setup documentation.
	Web browser is not set up properly.	Verify that the Web browser is installed and set up to work with your ISP.
	Cable/ DSL modem is not plugged in.	Plug in cable/DSL modem. You should see a "power" LED light on the front of the cable/DSL modem.

Solving Internet Access Problems *(Continued)*

Problem	Cause	Solution
Unable to connect to the Internet. (continued)	Cable/DSL service is not available or has been interrupted due to bad weather.	Try connecting to the Internet at a later time or contact your ISP. (If the cable/DSL service is connected, the "cable" LED light on the front of the cable/DSL modem will be on.)
	The CAT5 10/100 cable is disconnected.	Connect the CAT5 10/100 cable between the cable modem and the computer's RJ-45 connector. (If the connection is good, the "PC" LED light on the front of the cable/DSL modem will be on.)
	IP address is not configured properly.	Contact the ISP for the correct IP address.
	Cookies are corrupted.	<i>Windows XP</i> <ol style="list-style-type: none"> 1. Select Start > Control Panel. 2. Double-click Internet Options. 3. On the General tab, click the Delete Cookies button.
Cannot automatically launch Internet programs.	You must log on to the ISP before some programs will start.	Log on to the ISP and launch the desired program.

Solving Internet Access Problems *(Continued)*

Problem	Cause	Solution
Internet takes too long to download Web sites.	Modem is not set up properly.	<p>Verify that the correct modem speed and COM port are selected.</p> <p><i>For Windows XP</i></p> <ol style="list-style-type: none"> 1. Select Start > Control Panel. 2. Double-click System. 3. Click the Hardware tab. 4. In the Device Manager area, click the Device Manager button. 5. Double-click Ports (COM & LPT). 6. Right-click the COM port your modem uses, then click Properties. 7. Under Device status, verify that the modem is working properly. 8. Under Device usage, verify the modem is enabled. 9. If there are further problems, click the Troubleshoot button and follow the on-screen instructions.

Diagnostic Front Panel LEDs and Audible Codes

Diagnostic Front Panel LEDs and Audible Codes

Activity	Beeps	Possible Cause	Recommended Action
Green Power LED On.	None	Computer on.	None
Green Power LED flashes every two seconds.	None	Computer in Suspend to RAM mode (some models only) or normal Suspend mode.	Not support wake up by mouse/keyboard. Should be Press Power button.
CPU Fan weak (RPM < 600) or not turning, Display Warning message and Long Beep for 5 sec and shut down. System Fan weak (RPM < 600) or not turning, Display Warning message and Long Beep for 5 sec and shut down.	2	Processor thermal protection activated: A fan may be blocked or not turning. OR The heatsink/fan assembly is not properly attached to the processor.	<ol style="list-style-type: none"> 1. Ensure that the computer air vents are not blocked and the processor cooling fan is running. 2. Open hood, press power button, and see if the processor fan spins. If the processor fan is not spinning, make sure the fan's cable is plugged onto the system board header. Ensure the fan is fully/properly seated or installed. 3. If fan is plugged in and seated properly, but is not spinning, then replace processor fan. 4. Reseat processor heatsink and verify that the fan assembly is properly attached. 5. Contact an authorized reseller or service provider.
Red Power LED flashes five times, one every second, followed by a 2 second pause. Also 5 simultaneous beeps will be heard.	5	Pre-video memory error.	<ol style="list-style-type: none"> 1. Reseat DIMMs. Power on the system. 2. Replace DIMMs one at a time to isolate the faulty module. 3. Replace third-party memory with HP memory. 4. Replace the system board.
Red Power LED flashes 6 times, one every second, followed by a 2 second pause. Also 6 simultaneous beeps will be heard.	6	Pre-video graphics error.	<p>For systems with a graphics card:</p> <ol style="list-style-type: none"> 1. Reseat the graphics card. Power on the system. 2. Replace the graphics card. 3. Replace the system board. <p>For systems with integrated graphics, replace the system board.</p>

Diagnostic Front Panel LEDs and Audible Codes *(Continued)*

Activity	Beeps	Possible Cause	Recommended Action
Red Power LED flashes 8 times, one every second, followed by a 2 second pause. Also 8 simultaneous beeps will be heard.	8	Invalid ROM based on bad checksum.	<ol style="list-style-type: none"> 1. Reflash the system ROM with the latest BIOS image. 2. Replace the system board.
Inclining beeps when password entered.	Rapid incline	Incorrect password entered.	Enter the correct password.
Declining beeps when password entered.	Rapid decline	Correct password entered.	No action required.

Diagnostic Front Panel LEDs and Audible Codes *(Continued)*

Activity	Beeps	Possible Cause	Recommended Action
System does not power on and LEDs are not flashing.	None	System unable to power on.	<p>Press and hold the power button for less than 4 seconds. If the hard drive LED turns green, then:</p> <ol style="list-style-type: none"> 1. Check that the voltage selector, located on the rear of the power supply, is set to the appropriate voltage*. Proper voltage setting depends on your region. 2. Remove the expansion cards one at a time until the 5V_aux light on the system board turns on. 3. Replace the system board. <p>OR</p> <p>Press and hold the power button for less than 4 seconds. If the hard drive LED does not turn green then:</p> <ol style="list-style-type: none"> 1. Check that the unit is plugged into a working AC outlet. 2. Open hood and check that the power button harness is properly connected to the system board. 3. Check that both power supply cables are properly connected to the system board. 4. Check to see if the 5V_aux light on the system board is turned on. If it is turned on, then replace the power button harness. 5. If the 5V_aux light on the system board is not turned on, then replace the power supply. 6. Replace the system board.

Diagnostic Front Panel LEDs and Audible Codes (Continued)

Activity	Beeps	Possible Cause	Recommended Action
System gives an error message stating that "Error 912 - computer cover or side panel has been removed. Make sure that any system access was authorized and press F1 to continue".	Continuous beep for 5 seconds	The chassis side cover is open or would have been removed after previous power on.	<ol style="list-style-type: none"> 1. Make sure that the Chassis side cover is closed if not fix it as directed in the assembling guide. 2. Ensure that any system access was authorized, check all the hardware ensuring that no hardware has been changed or removed. Then enter the BIOS setup by pressing F10 then select Hardware Monitor setup and enable the Reset Case Open Status. 3. Refer to the F10 Utility Guide for its functionality and any further issues. 4. For maximum security, be sure to establish a setup password. The setup password prevents unauthorized access to the Computer Setup utility.

Restoring the Software

The Windows operating system and software can be restored to the original state that they were when you purchased the computer by using the *Restore Plus!* CD. See the documentation included with the *Restore Plus!* CD for complete instructions on using this feature.



In the event that you lose power during the initial operating system installation process, use the *Restore Plus!* CD to install the operating system.

Contacting Customer Support

For help and service, contact an authorized reseller or dealer. To locate a reseller or dealer near you, visit www.hp.com.



If you take the computer to an authorized reseller, dealer, or service provider for service, remember to provide the setup and power-on passwords if they are set.



Refer to the number listed in the warranty or in the *Worldwide Telephone Numbers Guide* on the *Library* CD for technical assistance.

Memory

Computers equipped with Intel-based processors come with double data rate synchronous dynamic random access memory (DDR2) dual inline memory modules (DIMMs).

The memory sockets on the system board can be populated with up to four industry-standard DIMMs. These memory module slots are populated with at least one preinstalled memory module. To achieve the maximum memory support, you can populate the system board with up to 4GB of memory configured in a high-performing dual channel mode.

For proper system operation, the computer supports DDR2-SDRAM DIMMs. The DIMMs must be industry-standard 240-pin, unbuffered PC2 4200 533 or 667 MHz-compliant, 1.8 volt DDR2-SDRAM DIMMs. The DDR2-SDRAM DIMMs must also:

- support PC2 4200 533MHz or 667MHz
- contain the mandatory JEDEC SPD information

In addition, the computer supports:

- 256Mbit, 512Mbit, and 1 Gbit non-ECC memory technologies
- single-sided and double-sided DIMMS
- DIMMs constructed with x8 and x16 DDR devices; DIMMs constructed with x4 SDRAM are not supported



The system will not start if you install unsupported DIMMs.
